

The image shows a white door set against a light-colored wall. On the wooden floor in front of the door, there is a silver door pull and a black door stopper. The door pull is a modern, cylindrical design with a flat top and a recessed area for the hand. The door stopper is a simple black cylinder with a silver top. In the background, a wooden side table with a plant and a teal cup is visible.

LNS
MANUFACTURING

DOOR ACCESSORIES & MORE/
ACCESORIOS PARA PUERTAS



DOOR CHAINS AND GUARDS / SEGURO PARA PUERTAS



PRIVACY DOOR GUARD

PASADOR DE SEGURIDAD

CHARACTERISTICS / CARACTERÍSTICAS: 1/50

- Mounts to frame
- Material: Stainless Steel
- Montaje en el marco
- Material: Acero Inoxidable

CODE/CÓDIGO	FINISH/ACABADO
JK007SS	● Satin
JK007MB	● Black/Negro

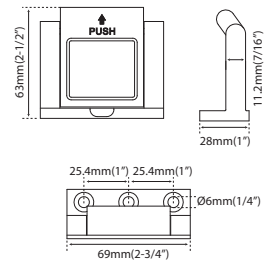

SECURITY DOOR GUARD

SEGURO PARA PUERTA

CHARACTERISTICS / CARACTERÍSTICAS: 20/200

- Mounts to door and frame
- Material: Zinc Alloy-Black Rubber
- Montaje en la puerta y en el marco
- Material: Zamak-Goma

CODE/CÓDIGO	FINISH/ACABADO
302JAKOSN	● Satin Nickel/Niquel Satin

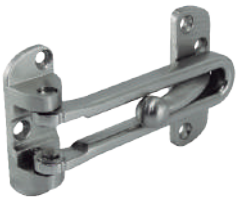
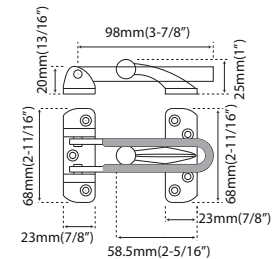

SECURITY DOOR GUARD

SEGURO PARA PUERTA

CHARACTERISTICS / CARACTERÍSTICAS: 20/200

- Mounts to door and frame
- Material: Zinc Alloy
- Montaje en la puerta y en el marco
- Material: Zamak

CODE/CÓDIGO	FINISH/ACABADO
301JAKOSN	● Satin Nickel/Niquel Satin
301JAKOCP	● Bright Chrome/Cromo Brillo

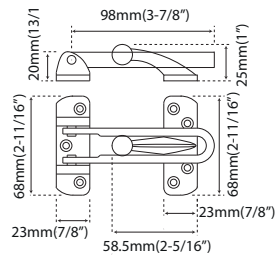

SECURITY DOOR GUARD

SEGURO PARA PUERTA

CHARACTERISTICS / CARACTERÍSTICAS: 5/40

- Mounts to door and frame
- Material: Brass
- Montaje en la puerta y en el marco
- Material: Latón

CODE/CÓDIGO	FINISH/ACABADO
7111ORB	● Matt Black/Negro Mate

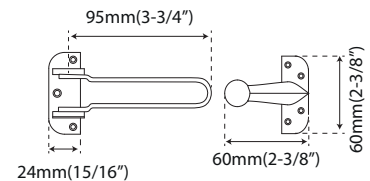

DOOR CHAIN
CADENA DE SEGURIDAD





DOOR CHAIN W/ LEATHER

CADENA DE SEGURIDAD

CHARACTERISTICS / CARACTERÍSTICAS:

5/100

- Mounts to door and frame
- Easy Installation
- Material: Stainless Steel 304
- Montaje en la puerta y en el marco
- Fácil Instalación
- Material: Acero Inoxidable 304

CODE/CÓDIGO FINISH/ACABADO

DG004SS ● Satin

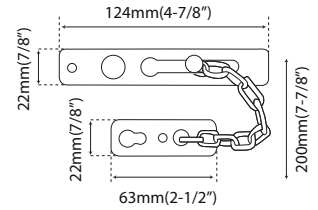

DOOR CHAIN

CADENA DE SEGURIDAD

CHARACTERISTICS / CARACTERÍSTICAS:

20/200

- Mounts to door and frame
- Easy Installation
- Material: Frame (Zinc Alloy)
- Chain (Chromed Steel)
- Montaje en la puerta y en el marco
- Fácil Instalación
- Material: Cuerpo (Zamak)
- Cadena (Acero Cromado)

CODE/CÓDIGO FINISH/ACABADO

300JAKOSN ● Satin
300JAKOCP ● Bright Chrome/Cromo Brillo

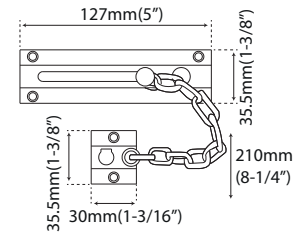

DOOR CHAIN

CADENA DE SEGURIDAD

CHARACTERISTICS / CARACTERÍSTICAS:

1/200

- Mounts to door and frame
- Material: Stainless Steel 304
- Montaje en la puerta y en el marco
- Material: Acero Inoxidable 304

CODE/CÓDIGO FINISH/ACABADO

DG001SS ● Satin

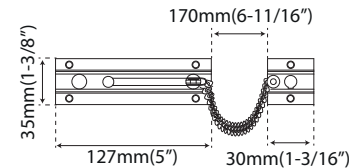

DOOR CHAIN

CADENA DE SEGURIDAD

CHARACTERISTICS / CARACTERÍSTICAS:

10/80

- Mounts to door and frame
- Material: Brass
- Montaje en la puerta y en el marco
- Material: Latón

CODE/CÓDIGO FINISH/ACABADO

7106ORB ● Matt Black/Negro Mate

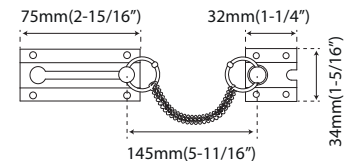

RETRACTABLE CHAIN-DOOR GUARD

CIERRE DE SEGURIDAD OCULTO

CHARACTERISTICS / CARACTERÍSTICAS:

1/100

- Mounts to door and frame
- Material: Zinc Alloy
- Chain (Chromed Steel)
- Montaje en la puerta y en el marco
- Material: Zamak
- Cadena (Acero Cromado)

CODE/CÓDIGO FINISH/ACABADO

DG0040SS ● Satin

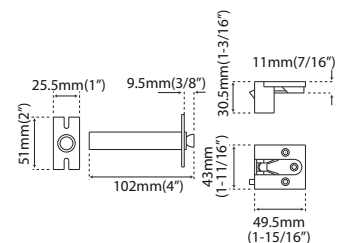

DOOR VIEWER

MIRILLAS

LNS
MANUFACTURING



SOLID BRASS 200° DOOR VIEWER W/ PRIVACY COVER

MIRILLA 200° CON CUBIERTA DE PRIVACIDAD



CHARACTERISTICS/CARACTERÍSTICAS:

1/20

- Drilling: 5/8" diameter bore
- Material: Brass
- View angle: 200°
- Lense are made of glass and not plastic
- Orificio de instalación 16mm
- Material: Latón
- Ángulo de vista: 200°
- Lente hecho con cristal y no plástico

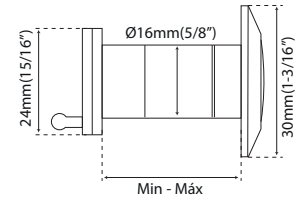

1/3 Hour Fire Rated/
1/3 de Hora Resistencia de fuego

DOOR THICKNESS/
ESPESOR DE LA PUERTA
Min - Max

CODE/CÓDIGO	FINISH/ACABADO	DOOR THICKNESS/ESPESOR DE LA PUERTA Min - Max
MJUL16356ON	● Matt Black/Negro Mate	35-60mm (1-3/8"-2-3/8")
MJUL16356OSN	● Matte Chrome/Cromo Mate	35-60mm (1-3/8"-2-3/8")
MJUL166085N	● Matt Black/Negro Mate	60-85mm (2-3/8"-3-3/8")
MJUL166085SN	● Matte Chrome/Cromo Mate	60-85mm (2-3/8"-3-3/8")

SOLID BRASS 160° DOOR VIEWER W/PRIVACY COVER

MIRILLA 160° CON CUBIERTA DE PRIVACIDAD



CHARACTERISTICS / CARACTERÍSTICAS:

20/200

- Drilling 9/16" diameter bore
- Material: Brass
- View angle: 160°
- Lense are made of glass and not plastic
- Orificio de instalación: 14mm
- Material: Latón
- Ángulo de vista: 160°
- Lente hecho con cristal y no plástico

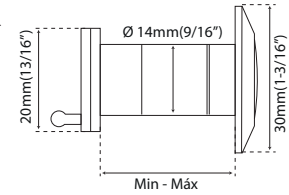

CODE/CÓDIGO	FINISH/ACABADO	DOOR THICKNESS/ESPESOR DE LA PUERTA Min - Max	DRILLING/ORIFICIO DE INSTALACIÓN
MJ141525CM	● Matte Chrome/Cromo Mate	15-25mm (9/16"-1")	14mm (9/16")
MJ142542CM	● Matte Chrome/Cromo Mate	25-42mm (1"-1-5/8")	14mm (9/16")
MJ143560CM	● Matte Chrome/Cromo Mate	35-60mm (1-3/8"-2-3/8")	14mm (9/16")
MJ143560NM	● Matt Black/Negro Mate	35-60mm (1-3/8"-2-3/8")	14mm (9/16")
MJ163560CM	● Matte Chrome/Cromo Mate	35-60mm (1-3/8"-2-3/8")	16mm (5/8")

SOLID BRASS 140° DOOR VIEWER

MIRILLA 140°

CHARACTERISTICS / CARACTERÍSTICAS:

20/300

- Drilling: 9/16" diameter bore
- Material: Brass
- View angle: 140°
- Orificio de instalación: 14mm
- Material: Latón
- Ángulo de vista: 140°

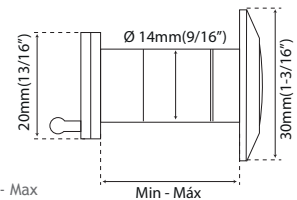

CODE/CÓDIGO	FINISH/ACABADO	DOOR THICKNESS/ESPESOR DE LA PUERTA Min - Max
MIR143560LC	● Matte Chrome/Cromo Mate	35mm-60mm (1-3/8"-2-3/8")
MIR143560LM	● Matte Brass/Latón Mate	35mm-60mm (1-3/8"-2-3/8")
MIR143560LP	● Polished Brass/Latón Pulido	35mm-60mm (1-3/8"-2-3/8")

COMMERCIAL PORTHOLE

MIRILLA PARA PUERTA

CHARACTERISTICS / CARACTERÍSTICAS:

1/4

- Ideal for commercial swinging doors
- Door thickness: 1-3/4"
- Includes 1/2" glass
- Material: Stainless Steel 304
- Ideal para puertas de madera o metal
- Espesor de la puerta: 45mm
- Incluye cristal: 12mm
- Material: Acero Inoxidable 304

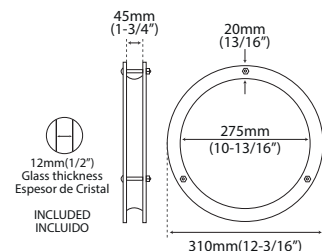

CODE/CÓDIGO	FINISH/ACABADO
DV-2010	● Satin



BALA WALL-MOUNT

TOPE DE PARED



CHARACTERISTICS / CARACTERÍSTICAS:

6/60

- Mounting hardware included
- Material: Solid Stainless Steel 304
- Montaje en la pared
- Material: Acero Inoxidable Sólido 304

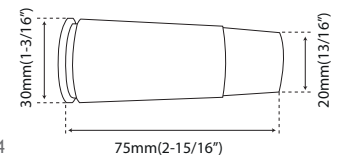

CODE/CÓDIGO	FINISH/ACABADO
PT-000003	● Satin

KONING WALL-MOUNT

TOPE DE PARED



CHARACTERISTICS / CARACTERÍSTICAS:

25

- Mounting hardware included
- Material: Solid Stainless Steel 304
- Montaje en la pared
- Material: Acero Inoxidable Sólido 304

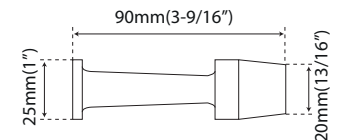

CODE/CÓDIGO	FINISH/ACABADO
PT-000046	● Satin

WALL-MOUNT DOOR STOP

TOPE DE PARED



CHARACTERISTICS / CARACTERÍSTICAS:

25

- Mounting hardware included
- Material: Solid Stainless Steel 304
- Montaje en la pared
- Material: Acero Inoxidable Sólido 304

CODE/CÓDIGO	FINISH/ACABADO	L
CMD325X65	● Satin	65mm(2-9/16")
CMD325X95	● Satin	95mm3-3/4")
CMD325X125	● Satin	125mm(4-15/16")

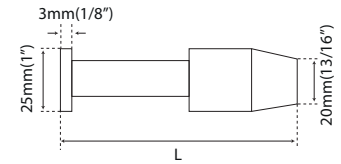

WALL-MOUNT RIGID DOOR STOP

TOPE DE PARED



CHARACTERISTICS / CARACTERÍSTICAS:

10/80

- Rigid door stop
- Mounting hardware included
- Material: Stainless Steel 304
- Tope de puerta rígido
- Montaje en la pared
- Material: Acero Inoxidable 304

CODE/CÓDIGO	FINISH/ACABADO
CMD008	● Satin
CMD008PSS	● Polished/Pulido

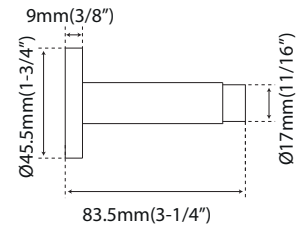

WALL-MOUNT RIGID DOOR STOP

TOPE DE PARED



CHARACTERISTICS / CARACTERÍSTICAS:

1/40

- Rigid door stop
- Mounting hardware included
- Material: Stainless Steel 304
- Tope de puerta rígido
- Montaje en la pared
- Material: Acero Inoxidable 304

CODE/CÓDIGO	FINISH/ACABADO
CMD020	● Satin

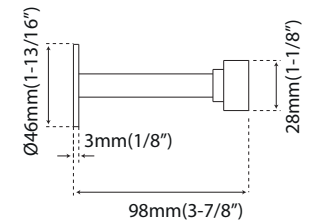

WALL-MOUNT DOOR STOP

TOPE DE PARED



CHARACTERISTICS / CARACTERÍSTICAS:

10/80

- Mounting hardware included
- Material: Solid Brass
- Montaje en la pared
- Material: Latón Sólido

CODE/CÓDIGO	FINISH/ACABADO
6124LA	● Antique Brass / Latón Antiguo
6124LP	● Polished Brass / Latón Pulido
6124NS	● Satin Nickel / Satin
6124ORB	● Black / Negro

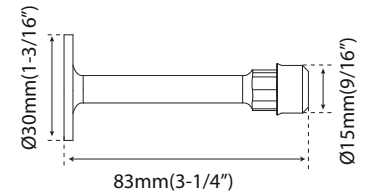

HEAVY DUTY WALL-MOUNT DOOR STOP

TOPE DE PARED



CHARACTERISTICS / CARACTERÍSTICAS:

2/16

- Wall-Mount
- Rigid door stop
- Material: Solid Brass
- Montaje en la pared
- Tope de puerta rígido
- Material: Latón Sólido

CODE/CÓDIGO	FINISH/ACABADO
6112NS	● Satin Nickel/Niquel Satin
6112ORB	● Matt Black/Negro Mate
6112LA	● Antique Brass / Latón Antiguo

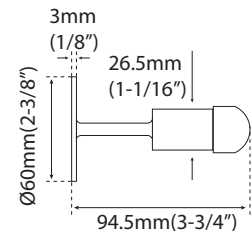

DOOR STOP W/ HOOK

TOPE DE PARED CON GANCHO



CHARACTERISTICS / CARACTERÍSTICAS:

4

- Heavy Duty
- Wall-mount
- Mounting hardware included
- Material: Brass
- Uso Rudo
- Montaje en la pared
- Material: Latón

CODE/CÓDIGO	FINISH/ACABADO
6113LA	● Antique Brass/Latón Antiguo
6113LP	● Polished Brass/Latón Pulido
6113NS	● Satin Nickel/Niquel Satin
6113ORB	● Matt Black/Negro Mate

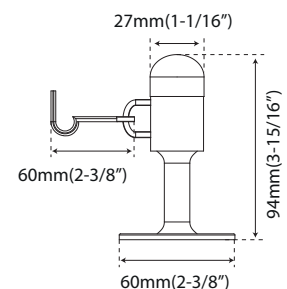

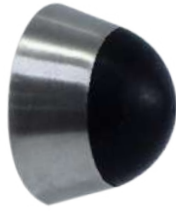

WALL-MOUNT DOOR STOP

TOPE DE PARED

CHARACTERISTICS / CARACTERÍSTICAS: 2/160

- Mounting hardware included
- Material: Stainless Steel 304
- Montaje en la pared
- Material: Acero Inoxidable 304

CODE/CÓDIGO	FINISH/ACABADO
CMD011	● Satin

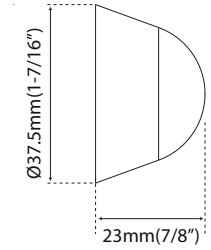

WALL-MOUNT DOOR STOP

TOPE DE PARED

CHARACTERISTICS / CARACTERÍSTICAS: 32/40

- Mounting hardware included
- Material: Stainless Steel 304
- Montaje en la pared
- Material: Acero Inoxidable 304

CODE/CÓDIGO	FINISH/ACABADO
CMD012	● Satin
CMD012PSS	● Polished/Pulido
CMD012N	● Matt Black/Negro Mate

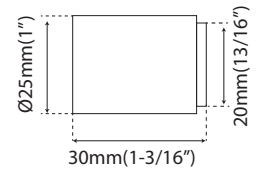

WALL-MOUNT DOOR STOP

TOPE DE PARED

CHARACTERISTICS / CARACTERÍSTICAS: 10/200

- Mounting hardware included
- Material: Stainless Steel 304
- Montaje en la pared
- Material: Acero Inoxidable 304

CODE/CÓDIGO	FINISH/ACABADO
CMD127	● Satin

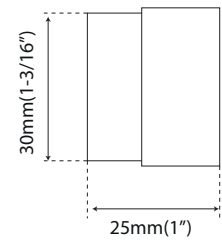

WALL-MOUNT DOOR STOP

TOPE DE PARED

CHARACTERISTICS / CARACTERÍSTICAS: 10

- Mounting hardware included
- Material: Stainless Steel 304
- Montaje en la pared
- Material: Acero Inoxidable 304

CODE/CÓDIGO	FINISH/ACABADO
CMS018	● Satin

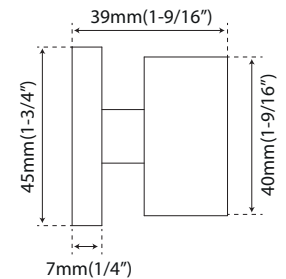



DOOR STOP WALL-MOUNT

TOPE DE PARED

CHARACTERISTICS / CARACTERÍSTICAS:

10/100

- Mounting hardware included
- Montaje en la pared
- Material: Brass
- Material: Latón

CODE/CÓDIGO FINISH/ACABADO

6130NS ● Satin Nickel/Niquel Satin
6130ORB ● Matt Black/Negro Mate

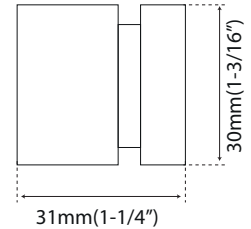

31mm(1-1/4")



DOOR STOP WALL-MOUNT

TOPE DE PARED

CHARACTERISTICS / CARACTERÍSTICAS:

10

- Mounting hardware included
- Montaje en la pared
- Material: Stainless Steel/ Gray Rubber
- Material: Acero Inoxidable/Goma: Gris

CODE/CÓDIGO FINISH/ACABADO

CMDS009 ● Satin

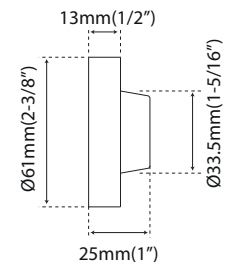

25mm(1")



ADHESIVE MOUNT WALL BUMBER-PLASTIC

TOPE DE GOMA BLANCA AUTOADHERIBLE A PARED

CHARACTERISTICS / CARACTERÍSTICAS:

10/50

- Self-adhesive
- Montaje en la pared-adherible (Adhesivo 3M)
- Material: Plastic
- Material: Plástico

CODE/CÓDIGO FINISH/ACABADO

TJG25 ○ White/Blanco

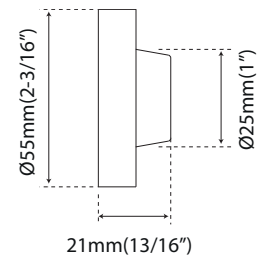

21mm(13/16")



SLIDE UNDER DOOR HOLDER

TOPE RETENEDOR MOVIBLE



CHARACTERISTICS / CARACTERÍSTICAS:

10/80

- Floor-mount
- Mounting hardware included
- Material: Stainless Steel 304
- Montaje en el piso
- Material: Acero Inoxidable 304

CODE/CÓDIGO	FINISH/ACABADO	A	DOOR THICKNESS/ ESPESOR DE LA PUERTA
TJ038SS	● Satin	65mm(2-9/16")	55mm(2-3/16")
TJ038SS90	● Satin	180mm(4-5/8")	90mm(3-9/16")
TJ038SS120	● Satin	180mm(4-5/8")	120mm(4-3/4")

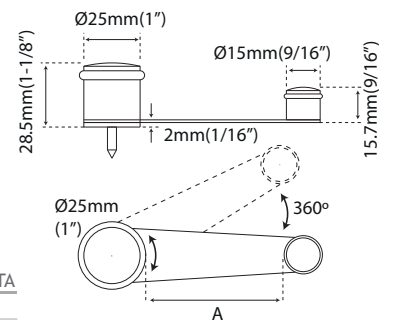

HEAVY DUTY HOOK HOLDER

TOPE CON GANCHO PARA PUERTAS PESADAS



CHARACTERISTICS / CARACTERÍSTICAS:

1/24

- Floor-mount; catch attaches to door
- Material: Stainless Steel 304
- Floor-mount; catch attaches to door
- Material: Stainless Steel 304

CODE/CÓDIGO	FINISH/ACABADO
JK13010	● Satin

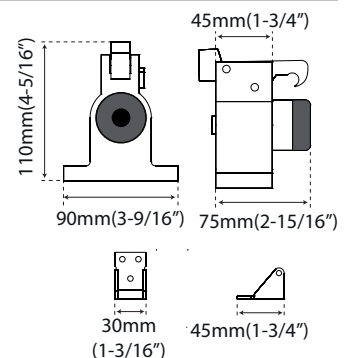

STEP DOWN DOOR HOLDER

RETENEDOR DE PIE



CHARACTERISTICS / CARACTERÍSTICAS:

10/50

- Door-mount
- Plunger projection: 1-1/8"
- Spring loaded
- Material: Stainless Steel 304
- Montaje en la puerta
- Medida de desplazamiento: 29mm
- Material: Acero Inoxidable 304

CODE/CÓDIGO	FINISH/ACABADO
WDS015	● Satin

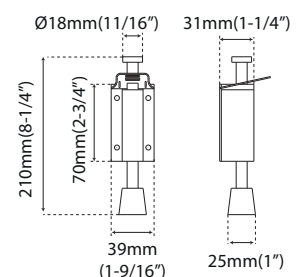

POP-UP PIN DOOR HOLDER

RETENEDOR DE PUERTA



CHARACTERISTICS / CARACTERÍSTICAS:

20

- Floor-mount
- Screws included
- Material: Stainless Steel 304
- Montaje en el piso
- Incluye tornillos
- Material: Acero Inoxidable 304

CODE/CÓDIGO FINISH/ACABADO

JK23009 ● Satin

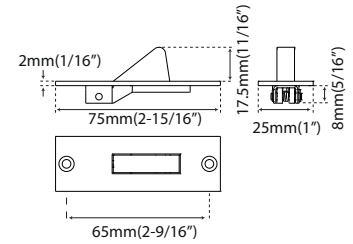

KICK DOWN HOLDER

TOPE RETENEDOR

CHARACTERISTICS / CARACTERÍSTICAS:

5/100

- Door-mount
- Screws included
- Heavy Duty
- Material: Solid Brass
- Montaje en la puerta
- Incluye tornillos
- Uso rudo
- Material: Latón Sólido

CODE/CÓDIGO FINISH/ACABADO

		A	B	C
6119NS	● Satin Nickel/Niquel Satin	29mm(1-1/8")	108mm(4-1/4")	45mm(1-3/4")
6119LA	● Antique/Latín Antiguo	29mm(1-1/8")	108mm(4-1/4")	45mm(1-3/4")
6119LP	● Polished Brass/Latón Pulido	29mm(1-1/8")	108mm(4-1/4")	45mm(1-3/4")
6119ORB	● Matt Black/Negro Mate	29mm(1-1/8")	108mm(4-1/4")	45mm(1-3/4")
6120NS	● Satin Nickel/Niquel Satin	32mm(1-1/4")	103mm(4-1/16")	40mm(1-9/16")
6120LA	● Antique Brass/Latón Antiguo	32mm(1-1/4")	103mm(4-1/16")	40mm(1-9/16")
6120LP	● Polished Brass/Latón Pulido	32mm(1-1/4")	103mm(4-1/16")	40mm(1-9/16")

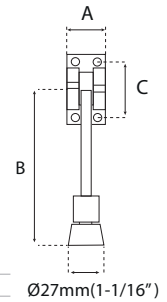

STEP DOWN HOLDER

TOPE DE PISO

CHARACTERISTICS / CARACTERÍSTICAS:

5

- Door-mount
- Plunger projection: 1/2"
- Heavy Duty
- Material: Solid Brass
- Montaje en la puerta
- Medida de desplazamiento: 13mm
- Uso Rudo
- Material: Latón Sólido

CODE/CÓDIGO FINISH/ACABADO

DS0803 ● Satin Nickel/Niquel Satin

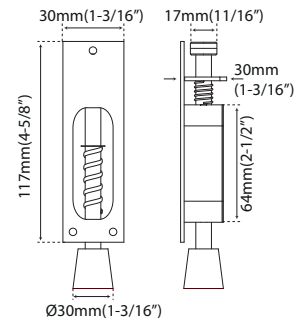



MAGNETIC DOOR STOP MOUNT

TOPE MAGNÉTICO

CHARACTERISTICS / CARACTERÍSTICAS:

- Magnetic
- Heavy Duty
- Holds door open
- Mounting hardware included
- Material: Stainless Steel 304
- Magnético
- Uso Rudo
- Mantiene la puerta abierta
- Montaje en la puerta y piso
- Material: Acero Inoxidable 304

CODE/CÓDIGO FINISH/ACABADO
JK13186 ● Satin

10

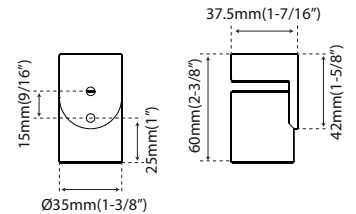

WALL OR FLOOR-MOUNT

TOPE MAGNÉTICO

CHARACTERISTICS / CARACTERÍSTICAS:

- Magnetic
- Holds door open
- Hardware included
- Material: Stainless Steel 304/Zinc Alloy
- Magnético
- Mantiene la puerta abierta
- Montaje en la pared o piso
- Material: Acero Inoxidable 304/Zamak

CODE/CÓDIGO FINISH/ACABADO
WDS019SS ● Satin Stainless Steel/Acero Inoxidable 304
WDS019 ● Satin Nickel/Niquel Satin Zinc Alloy/Zamak
WDS019LSS ● Satin Stainless Steel/Acero Inoxidable 304

10/100

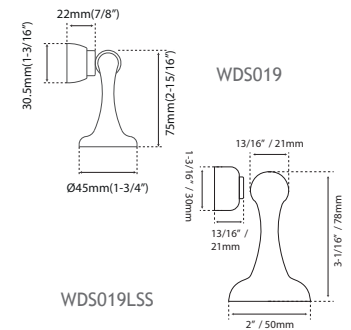

FLOOR-MOUNT

TOPE MAGNÉTICO

CHARACTERISTICS / CARACTERÍSTICAS:

- Magnetic
- Holds door open
- Hardware and catch included
- Material: Zinc Alloy
- Magnético
- Mantiene la puerta abierta
- Montaje en el piso
- Material: Zamak

CODE/CÓDIGO FINISH/ACABADO
800ZBM2 ● Black/Negro
800ZAB2 ● Bronze/Bronce
800ZCP2 ● Bright Chrome/Cromo Brilló
800ZNS2 ● Satin Nickel/Niquel Satin

10/100

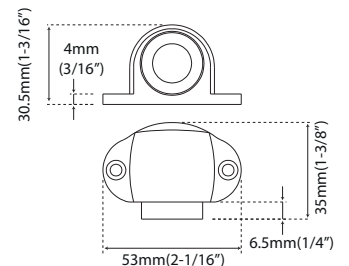

CONCEALED MAGNETIC CATCH

TOPE MAGNÉTICO

CHARACTERISTICS / CARACTERÍSTICAS:

- Door-mount
- Material: Steel
- Montaje en la puerta
- Material: Acero

CODE/CÓDIGO FINISH/ACABADO
JK17010 ● Satin

1

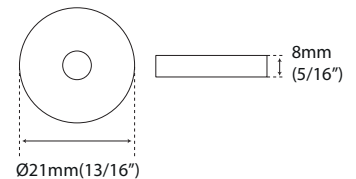

MAGNETIC STOPS

TOPES MAGNÉTICOS





FLOOR-MOUNT

TOPE DE PISO

CHARACTERISTICS / CARACTERÍSTICAS:

- Mounting hardware included
- Material: Solid Stainless Steel 304
- Montaje en el piso
- Material: Acero Inoxidable Sólido 304



CODE/CÓDIGO	FINISH/ACABADO	A	
CMD028G	● Satin	25mm(1")	30/240
CMD028GCSS	● Copper/Cobre	25mm(1")	20/200
CMD028GPSS	● Polished/Pulido	25mm(1")	30/240
CMD028P	● Satin	20mm(13/16")	20/200
CMD028PN	● Matt Black/Negro Mate	20mm(13/16")	20/250
CMD028PPSS	● Polished/Pulido	20mm(13/16")	20/200

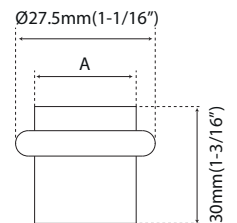

FLOOR-MOUNT 2" HIGH

TOPE DE PISO 2" ALTO

CHARACTERISTICS / CARACTERÍSTICAS:

20/100

- Mounting hardware included
- Material: Solid Stainless Steel 304
- Montaje en el piso
- Material: Acero Inoxidable Sólido 304



CODE/CÓDIGO	FINISH/ACABADO
PT-000728	● Satin

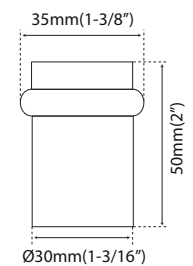

FLOOR-MOUNT

TOPE DE PISO

CHARACTERISTICS / CARACTERÍSTICAS:

20/200

- Mounting hardware included
- Material: Solid Stainless Steel 304
- Montaje en el piso
- Material: Acero Inoxidable Sólido 304



CODE/CÓDIGO	FINISH/ACABADO
CMD029	● Satin
CMD029CSS	● Copper/Cobre
CMD029N	● Matt Black/Negro Mate
CMD029PSS	● Polished/Pulido

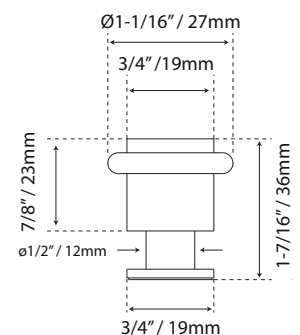

FLOOR-MOUNT

TOPE DE PISO



CHARACTERISTICS / CARACTERÍSTICAS: 25/200

- Mounting hardware included
- Material: Solid Stainless Steel 304
- Montaje en el piso
- Material: Acero Inoxidable Sólido 304

CODE/CÓDIGO	FINISH/ACABADO	A	B	C
CMD220X35	● Satin	35mm(1-3/8")	Ø28mm(1-1/8")	Ø20mm(13/16")
CMD235X50	● Satin	50mm(2")	Ø45mm(1-3/4")	Ø35mm(1-3/8")

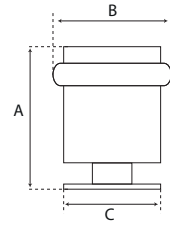

FLOOR-MOUNT

TOPE DE PISO



CHARACTERISTICS / CARACTERÍSTICAS: 25/250

- Mounting hardware included
- Material: Solid Stainless Steel 304
- Montaje en el piso
- Material: Acero Inoxidable Sólido 304

CODE/CÓDIGO	FINISH/ACABADO	A	B	C
TJ19X25	● Satin	19mmx25mm(3/4"x1")		24mm(15/16")
TJ19X30	● Satin	19mmx30mm(3/4"x1-3/16")		24mm(15/16")
TJ30X40	● Satin	30mmx40mm(1-3/16"x1-9/16")		35mm(1-3/8")

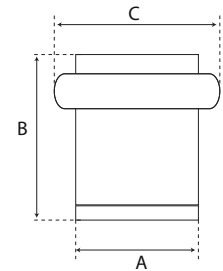

FLOOR-MOUNT

TOPE DE PISO



CHARACTERISTICS / CARACTERÍSTICAS: 20/200

- Mounting hardware included
- Material: Solid Stainless Steel 304
- Montaje en el piso
- Material: Acero Inoxidable Sólido 304

CODE/CÓDIGO	FINISH/ACABADO
CMD003A	● Satin
CMD003APSS	● Polished/Pulido

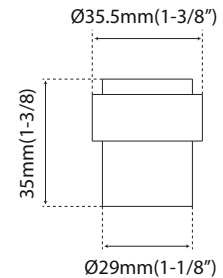

FLOOR-MOUNT

TOPE DE PISO



CHARACTERISTICS / CARACTERÍSTICAS: 10/100

- Mounting hardware included
- Material: Solid Stainless Steel 304 with Black Rubber
- Montaje en el piso
- Material: Acero Inoxidable Sólido 304 con Goma Negra

CODE/CÓDIGO	FINISH/ACABADO
CMD5029	● Satin

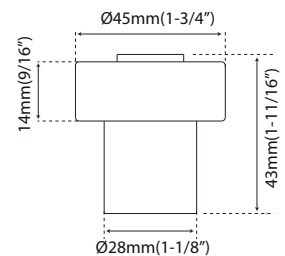

FLOOR-MOUNT

TOPE DE PISO



CHARACTERISTICS / CARACTERÍSTICAS: 10/100

- Mounting hardware included
- Material: Stainless Steel 304 with Black Rubber
- Montaje en el piso
- Material: Acero Inoxidable 304 con Goma Negra

CODE/CÓDIGO	FINISH/ACABADO	Ø	HEIGHT - ALTURA (H)
JK1318530	● Satin	Ø30mm(1-3/16")	30mm(1-3/16")
JK1318550	● Satin	Ø50mm(1-15/16")	30mm(1-3/16")

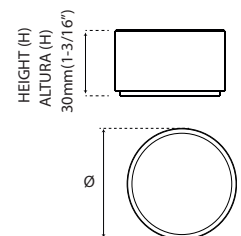



FLOOR-MOUNT

TOPE DE PISO

CHARACTERISTICS / CARACTERÍSTICAS:

10/80

- Mounting hardware included
- Material: Stainless Steel 304
- Montaje en el piso
- Material: Acero Inoxidable 304

CODE/CÓDIGO	FINISH/ACABADO
CMD013	● Satin

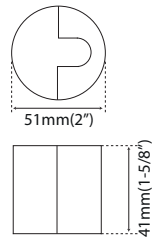

FLOOR-MOUNT

TOPE DE PISO

CHARACTERISTICS / CARACTERÍSTICAS:

15/120

- Mounting hardware included
- Material: Stainless Steel 304 / Zinc Alloy
- Montaje en el piso
- Material: Acero Inoxidable 304/Zamak

CODE/CÓDIGO	FINISH/ACABADO
CMD025	● Satin Stainless Steel/Acero Inoxidable
CMD025ZA	● Satin Nickel/Niquel Satin Zinc Alloy/Zamak

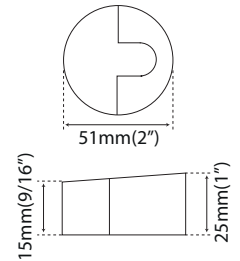

DOME

TOPE MEDIA LUNA

CHARACTERISTICS / CARACTERÍSTICAS:

20/160

- Mounting hardware included
- Material: Stainless Steel 304
- Montaje en el piso
- Material: Acero Inoxidable 304

CODE/CÓDIGO	FINISH/ACABADO
CMD001	● Satin
CMD001AB	● Antique Brass/Latón Antiguo
CMD001PSS	● Polished/Pulido
CMD001N	● Black/Negro

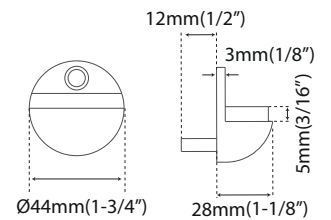

DOME

TOPE MEDIA LUNA

CHARACTERISTICS / CARACTERÍSTICAS:

30/300

- Mounting hardware included
- Material: Zinc Alloy
- Montaje en el piso
- Material: Zamak

CODE/CÓDIGO	FINISH/ACABADO
5AB	● Bronze/Bronce
5CP	● Bright Chrome/Cromo brillo
5NS	● Satin Nickel/Niquel Satin
5N	● Black/Negro

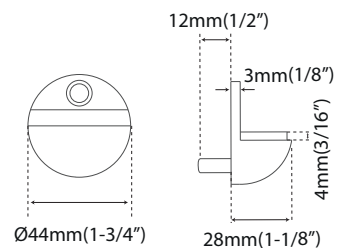

HI-RISE DOME

TOPE DE PISO

CHARACTERISTICS / CARACTERÍSTICAS:

10/100

- Mounting hardware included
- Material: Zinc Alloy
- Montaje en el piso
- Material: Zamak

CODE/CÓDIGO	FINISH/ACABADO
CMDS011	● Satin Nickel/Niquel Satin

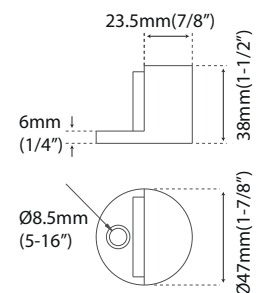



FLOOR-MOUNT

TOPE DE PISO

CHARACTERISTICS / CARACTERÍSTICAS:

- Mounting hardware included
- Material: Stainless Steel 304
- Montaje en el piso
- Material: Acero Inoxidable 304

CODE/CÓDIGO FINISH/ACABADO
CMD022 ● Satin

10

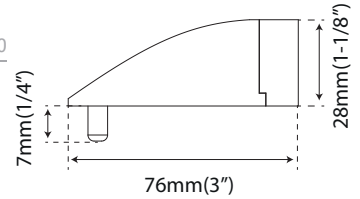

FLOOR-MOUNT

TOPE DE PISO

CHARACTERISTICS / CARACTERÍSTICAS:

- Mounting hardware included
- Material: Stainless Steel 304
- Montaje en el piso
- Material: Acero Inoxidable 304

CODE/CÓDIGO FINISH/ACABADO
CMD5035 ● Satin

10

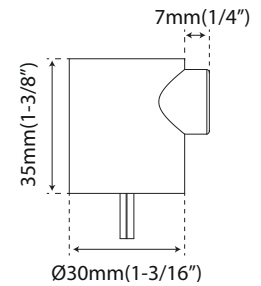

FLOOR-MOUNT

TOPE DE PISO

CHARACTERISTICS / CARACTERÍSTICAS:

- Mounting hardware included
- Material: Stainless Steel 304
- Montaje en el piso
- Material: Acero Inoxidable 304

CODE/CÓDIGO FINISH/ACABADO
CMD5037 ● Satin

10

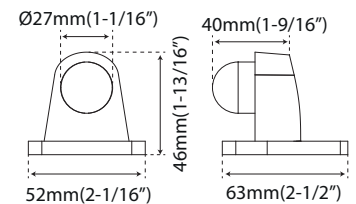

HEAVY DUTY STOP

TOPE DE PISO USO RUDO

CHARACTERISTICS / CARACTERÍSTICAS:

- Floor-mount
- Mounting hardware included
- Material: Stainless Steel 304
- Montaje en el piso
- Material: Acero Inoxidable 304

CODE/CÓDIGO FINISH/ACABADO
CMD5046 ● Satin

2

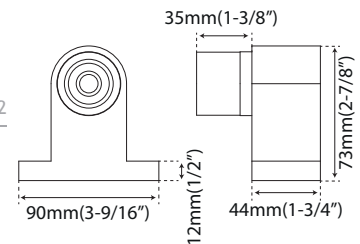



FLOOR-MOUNT

TOPE DE PISO

CHARACTERISTICS / CARACTERÍSTICAS:

12

- Mounting hardware included
- Material: Stainless Steel 304
- Montaje en el piso
- Material: Acero Inoxidable 304

CODE/CÓDIGO FINISH/ACABADO

JK13005 ● Satin

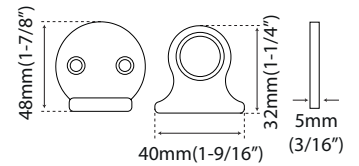

FLOOR-MOUNT

TOPE DE PISO

CHARACTERISTICS / CARACTERÍSTICAS:

50

- Mounting hardware included
- Material: Stainless Steel 304
- Montaje en el piso
- Material: Acero Inoxidable 304

CODE/CÓDIGO FINISH/ACABADO

JK13119 ● Satin

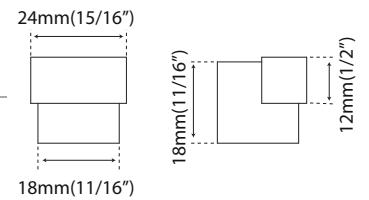

FLOOR-MOUNT

TOPE DE PISO

CHARACTERISTICS / CARACTERÍSTICAS:

20

- Mounting hardware included
- Material: Stainless Steel 304
- Montaje en el piso
- Material: Acero Inoxidable 304

CODE/CÓDIGO FINISH/ACABADO

JK13356 ● Satin

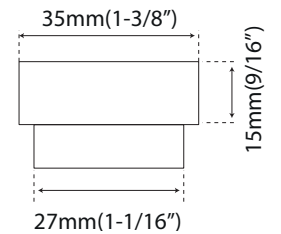

DOOR STOP BASE

BASE PARA TOPE

CHARACTERISTICS / CARACTERÍSTICAS:

100

- Floor, wall or glass-mount
- Fixation with 3M Adhesive
- Compatible with JK1318530, JK1318550, JK13186
- Material: Stainless Steel 304
- Montaje en el piso, pared o cristal
- Fijación con Adhesivo 3M
- Compatible con tope JK1318530, JK1318550, JK13186
- Material: Acero Inoxidable 304

CODE/CÓDIGO	FINISH/ACABADO	Ø
JK13BS25	● Satin	25mm(1")
JK13BS30	● Satin	30mm(1-3/16")
JK13BS35	● Satin	35mm(1-3/8")

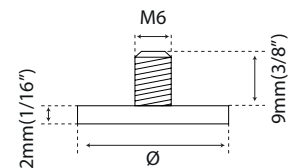

FLUSH BOLT

PASADOR DE EMBUTIR

CHARACTERISTICS / CARACTERÍSTICAS:

1/50

- Strike included
- Flip down lever
- Rod throw: 9/16"
- Material: Stainless Steel 304
- Palanca hacia abajo
- Alcance de la barra: 15mm
- Material: Acero Inoxidable 304

CODE/CÓDIGO	FINISH/ACABADO	L
WP6006	● Satin	152mm(6")
WP6008	● Satin	203mm(8")
WP60010	● Satin	254mm(10")
WP60012	● Satin	305mm(12")
WP60024	● Satin	609mm(24")

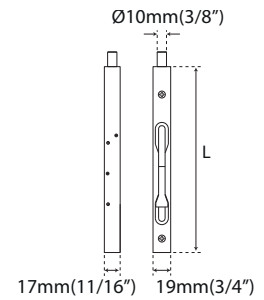

CORNER FLUSH BOLT

PASADOR DE EMBUTIR

CHARACTERISTICS / CARACTERÍSTICAS:

2/100

- Flip down lever
- Strike included
- Rod throw: 9/16"
- Material: Stainless Steel 304
- Palanca hacia abajo
- Alcance de la barra: 14mm
- Material: Acero Inoxidable 304

CODE/CÓDIGO	FINISH/ACABADO	L
PJ6006	● Satin	152mm(6")
PJ6008	● Satin	203mm(8")
PJ60010	● Satin	254mm(10")
PJ60012	● Satin	305mm(12")

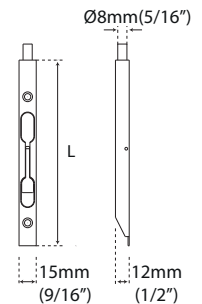

FLUSH BOLT W/ EXTENTION

PASADOR DE MAROMA CON EXTENSIÓN DE 12"

CHARACTERISTICS / CARACTERÍSTICAS:

2/100

- Flip down lever
- Rod throw: 3/4"
- Material: Stainless Steel 304
- Palanca hacia abajo
- Alcance de la barra: 19mm
- Material: Acero Inoxidable 304

CODE/CÓDIGO	FINISH/ACABADO	L
PJE6SS	● Satin	152mm(6")
PJE12SS	● Satin	305mm(12")

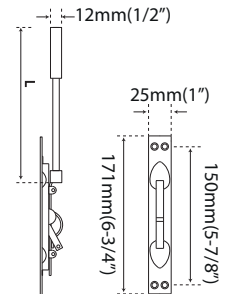

CORNER FLUSH BOLT

PASADOR DE EMBUTIR

CHARACTERISTICS / CARACTERÍSTICAS:

10/100

- Slide down lever
- Strike included
- Rod throw: 1"
- Material: Stainless Steel 304
- Alcance de la barra: 25mm
- Material: Acero Inoxidable 304

CODE/CÓDIGO	FINISH/ACABADO	L
WP4026	● Satin	152mm(6")
WP4028	● Satin	203mm(8")
WP40212	● Satin	305mm(12")

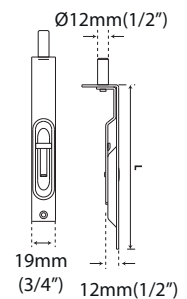

AUTOMATIC FLUSH BOLT

PASADOR DE EMBUTIR AUTOMÁTICO

CHARACTERISTICS / CARACTERÍSTICAS:

2/100

- Sold as set
- Strike included
- Rod throw: 11/16"
- Material: Stainless Steel 304
- Alcance de barra: 17mm
- Material: Acero Inoxidable 304

CODE/CÓDIGO	FINISH/ACABADO
502150	● Satin

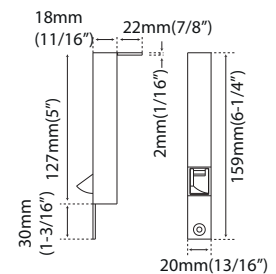



CORNER FLUSH BOLT

PASADOR DE EMBUTIR

CHARACTERISTICS / CARACTERÍSTICAS:

10

- Slide down lever
- Strike included
- Rod throw: 1"
- Material: Brass
- Deslice la palanca hacia abajo
- Alcance de la barra: 25mm
- Material: Latón

CODE/CÓDIGO	FINISH/ACABADO	L
5605NS	● Satin Nickel/Niquel Satin	127mm(5")
5606NS	● Satin Nickel/Niquel Satin	152mm(6")
5608INOX	● Satin Nickel/Niquel Satin	203mm(8")
5612LP	● Polished Brass/Latón Pulido	305mm(12")
5612NS	● Satin Nickel/Niquel Satin	305mm(12")

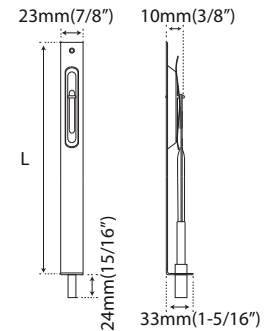

CORNER FLUSH BOLT

PASADOR DE EMBUTIR

CHARACTERISTICS / CARACTERÍSTICAS:

5

- Flip down lever
- Strike included
- Rod throw: 15/16"
- Material: Brass
- Palanca hacia abajo
- Alcance de la barra: 24mm
- Material: Latón

CODE/CÓDIGO	FINISH/ACABADO	L
5705LA	● Antique Brass/Latón Antiguo	127mm(5")
5705LP	● Polished Brass/Latón Pulido	127mm(5")
5705NS	● Satin Nickel/Niquel Satin	127mm(5")
5706NS	● Satin Nickel/Niquel Satin	153mm(6")
5706ORB	● Matt Black / Negro Mate	153mm(6")
5708NS	● Satin Nickel/Niquel Satin	203mm(8")
5708LP	● Polished Brass/Latón Pulido	203mm(8")

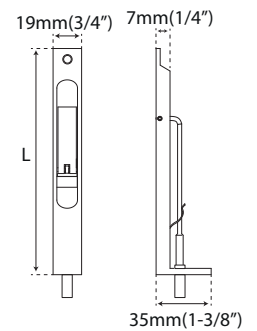

FLUSH BOLT W/ EXTENSION 12"

PASADOR

CHARACTERISTICS / CARACTERÍSTICAS:

5

- Rod throw: 5/8"
- Material: Satin Nickel
- Alcance de la barra: 16mm
- Material: Niquel Satin

CODE/CÓDIGO	FINISH/ACABADO
5906NS	● Satin

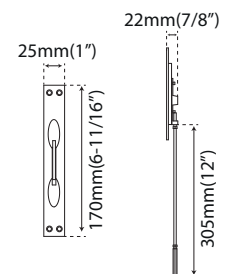

DUST PROOF STRIKE

CUBRE POLVO

CHARACTERISTICS / CARACTERÍSTICAS:

5

- Used with flush bolt
- Help stabilize doors
- Spring loaded top cover
- Material: Stainless Steel 304
- Ideal para pasadores de embutir
- Ayuda a estabilizar las puertas
- Cubierta superior con resorte
- Material: Acero Inoxidable 304

CODE/CÓDIGO	FINISH/ACABADO	A	B
JCDP001	● Satin	ø20mm(13/16")	30mm(1-3/16")
JCDP002	● Satin	ø25mm(1")	39mm(1-9/16")

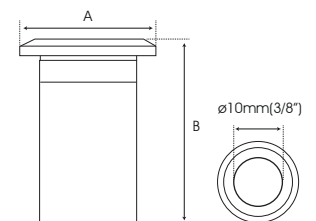

BARREL SURFACE BOLT

PASADOR DE SOBREPONER

CHARACTERISTICS / CARACTERÍSTICAS:

5/100

- For use on doors, gates, cabinets
- Non-handed
- Material: Stainless Steel 304
- Para uso en puertas, portones, armarios
- Material: Acero Inoxidable 304

CODE/CÓDIGO	FINISH/ACABADO	A	ROD THROW/ ALCANCE DE LA BARRA
38530	● Satin	30mm(1-3/16")	17mm(11/16")
38540	● Satin	40mm(1-9/16")	25mm(1")
38550	● Satin	50mm(1-15/16")	27mm(1-1/16")
38580	● Satin	80mm(3-1/8")	27mm(1-1/16")

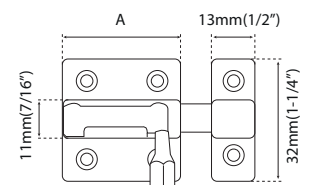

ROTATING PRIVACY BOLT

PASADOR DE GIRO

CHARACTERISTICS / CARACTERÍSTICAS:



- Non-handed
- Ideal for bathroom stalls, cabinets, gates, etc.
- Material: Zinc Alloy
- Ideal para baños, armarios, puertas, etc.
- Material: Zamak

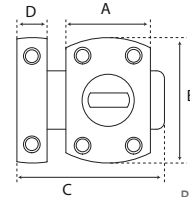

CODE/CÓDIGO	FINISH/ACABADO	A	B	C	D	ROD THROW/ ALCANCE DE LA BARRA
PJ620-30AB	● Antique Brass/Latón Antiguo	30mm(1-3/16")	41mm(1-5/8")	50mm(1-15/16")	11mm(7/16")	14mm(9/16")
PJ620-30CR	● Bright Chrome/Cromo Brillo	30mm(1-3/16")	41mm(1-5/8")	50mm(1-15/16")	11mm(7/16")	14mm(9/16")
PJ620-30NS	● Satin	30mm(1-3/16")	41mm(1-5/8")	50mm(1-15/16")	11mm(7/16")	14mm(9/16")
PJ620-40AB	● Antique Brass/Latón Antiguo	40mm(1-9/16")	55mm(2-3/16")	65mm(2-9/16")	16mm(5/8")	22mm(7/8")
PJ620-40CR	● Bright Chrome/Cromo Brillo	40mm(1-9/16")	55mm(2-3/16")	65mm(2-9/16")	16mm(5/8")	22mm(7/8")
PJ620-40NS	● Satin	40mm(1-9/16")	55mm(2-3/16")	65mm(2-9/16")	16mm(5/8")	22mm(7/8")
PJ620-40BM	● Black/Negro	40mm(1-9/16")	55mm(2-3/16")	65mm(2-9/16")	16mm(5/8")	22mm(7/8")

SURFACE BOLT

PASADOR DE SOBREPONER

CHARACTERISTICS / CARACTERÍSTICAS:



- Non-handed
- Material: Brass
- Material: Latón

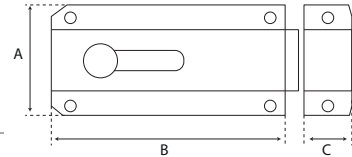

CODE/CÓDIGO	FINISH/ACABADO	A	B	C	ROD THROW/ ALCANCE DE LA BARRA
4702-2LA	● Antique Brass/Latón Antiguo	34mm(1-5/16")	38mm(1-1/2")	8mm(5/16")	8mm(5/16")
4702-2LP	● Polished Brass/Latón Pulido	34mm(1-5/16")	38mm(1-1/2")	8mm(5/16")	8mm(5/16")
4702-2NS	● Satin Nickel/Niquel Satin	34mm(1-5/16")	38mm(1-1/2")	8mm(5/16")	8mm(5/16")
4703-3LA	● Antique Brass/Latón Antiguo	29mm(1-1/8")	67mm(2-5/8")	15mm(9/16")	15mm(9/16")
4703-3LP	● Polished Brass/Latón Pulido	29mm(1-1/8")	67mm(2-5/8")	15mm(9/16")	15mm(9/16")
4703-3NS	● Satin Nickel/Niquel Satin	29mm(1-1/8")	67mm(2-5/8")	15mm(9/16")	15mm(9/16")
4703-3ORB	● Matt Black/Negro Mate	29mm(1-1/8")	67mm(2-5/8")	15mm(9/16")	15mm(9/16")
4704-4LA	● Antique Brass/Latón Antiguo	37mm(1-7/16")	92mm(3-5/8")	15mm(9/16")	15mm(9/16")
4704-4LP	● Polished Brass/Latón Pulido	37mm(1-7/16")	92mm(3-5/8")	15mm(9/16")	15mm(9/16")
4704-4NS	● Satin Nickel/Niquel Satin	37mm(1-7/16")	92mm(3-5/8")	15mm(9/16")	15mm(9/16")
4704-4LORB	● Matt Black/Negro Mate	30mm(1-3/16")	92mm(3-5/8")	15mm(9/16")	15mm(9/16")
4708-8LA	● Antique Brass/Latón Antiguo	37mm(1-7/16")	177mm(6-15/16")	26mm(1")	26mm(1")
4708-8LP	● Polished Brass/Latón Pulido	37mm(1-7/16")	177mm(6-15/16")	26mm(1")	26mm(1")
4708-8NS	● Satin Nickel/Niquel Satin	37mm(1-7/16")	177mm(6-15/16")	26mm(1")	26mm(1")
4708-8ORB	● Matt Black/Negro Mate	29mm(1-1/8")	194mm(7-5/8")	26mm(1")	15mm(9/16")
4724-24LP	● Polished Brass/Latón Pulido	37mm(1-7/16")	59mm(23-1/16")	26mm(1")	26mm(1")
4724-24NS	● Satin Nickel/Niquel Satin	37mm(1-7/16")	59mm(23-1/16")	26mm(1")	26mm(1")



SURFACE BOLT

PASADOR

CHARACTERISTICS / CARACTERÍSTICAS:



- Rod throw: 1-3/8"
- Material: Stainless Steel 304
- Alcance de la barra: 35mm
- Material: Acero Inoxidable 304

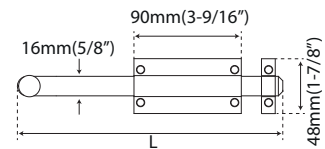

CODE/CÓDIGO	FINISH/ACABADO	L
PJ317/250	● Satin	250mm(9-13/16")
PJ317/300	● Satin	300mm(11-13/16")
PJ317/400	● Satin	400mm(15-3/4")
PJ317/500	● Satin	500mm(19-11/16")

DUTH SURFACE BOLT

PASADOR HOLANDESE

CHARACTERISTICS / CARACTERÍSTICAS:



- Rod throw: 17mm(11/16")
- Material: Zinc Alloy
- Alcance de la barra: 17mm(11/16")
- Material: Zamak

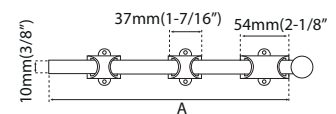
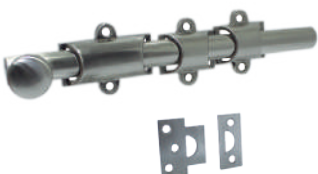

CODE/CÓDIGO	FINISH/ACABADO	A
5000NS4	● Satin Nickel/Niquel Satin	101mm(4")
5000NS6	● Satin Nickel/Niquel Satin	152mm(6")
5000NS8	● Satin Nickel/Niquel Satin	203mm(8")
5000N10	● Satin Nickel/Niquel Satin	254mm(10")
5000NS12	● Satin Nickel/Niquel Satin	305mm(12")



BARREL SURFACE BOLT

PASADOR DE SOBREPONER

CHARACTERISTICS / CARACTERÍSTICAS:

- Non-handed
- Rod throw: 7/8"
- Material: Stainless Steel 304
- Alcance de la barra: 22mm
- Material: Acero Inoxidable 304

CODE/CÓDIGO	FINISH/ACABADO	A	B
1004S	● Satin	100mm(4")	25mm(1")
1004SORB	● Matt Black/Negro Mate	100mm(4")	25mm(1")
1004L	● Brass / Latón	100mm(4")	25mm(1")
1006S	● Satin	150mm(6")	29mm(1-1/8")
1008S	● Satin	200mm(8")	29mm(1-1/8")

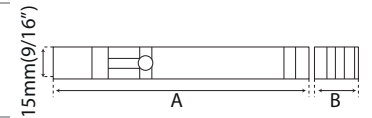

BARREL SURFACE BOLT

PASADOR DE SOBREPONER

CHARACTERISTICS / CARACTERÍSTICAS:

- Heavy Duty
- For use on gates
- Non-handed
- Material: Stainless Steel 304
- Uso Rudo
- Para uso en puertas
- Material: Acero Inoxidable 304

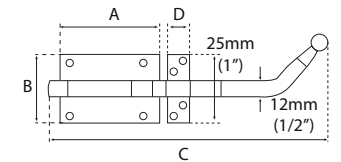

CODE/CÓDIGO	FINISH/ACABADO	A	B	C	D	ROD THROW ALCANCE DE LA BARRA
318IOX200	● Satin	85mm(3-3/8")	67mm(2-5/8")	200mm(7-7/8")	67mm(2-5/8")	44mm(1-3/4")
318IOX250	● Satin	85mm(3-3/8")	67mm(2-5/8")	250mm(9-13/16")	67mm(2-5/8")	41mm(1-5/8")
318IOX300	● Satin	21mm(13/16")	73mm(2-7/8")	300mm(11-13/16")	75mm(2-15/16")	65mm(2-9/16")
318IOX400	● Satin	21mm(13/16")	73mm(2-7/8")	400mm(15/3/4")	75mm(2-15/16")	65mm(2-9/16")

SECURITY BARREL SURFACE BOLT

PASADOR DE SOBREPONER

CHARACTERISTICS / CARACTERÍSTICAS:

- For use doors, gates, cabinets
- Non-handed
- Material: Stainless Steel 304
- Para uso de puertas, portones, armarios
- Material: Acero Inoxidable 304

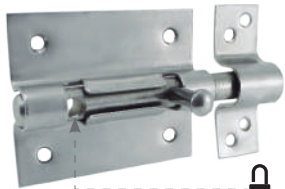
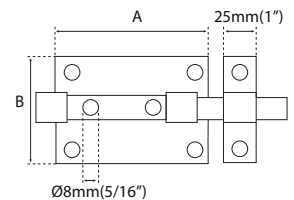

Padlock hole
Ø8mm(5/16")

CODE/CÓDIGO	FINISH/ACABADO	A	B	ROD THROW ALCANCE DE LA BARRA
455IOX70	● Satin	70mm(2-3/4")	67mm(2-5/8")	34mm(1-5/16")
455IOX85	● Satin	85mm(3-3/8")	67mm(2-5/8")	44mm(1-3/4")
455IOX100	● Satin	100mm(3-15/16")	67mm(2-5/8")	49mm(1-15/16")
455IOX120	● Satin	120mm(4-3/4")	73mm(2-7/8")	65mm(2-9/16")

BARREL SURFACE BOLT

PASADOR

CHARACTERISTICS / CARACTERÍSTICAS:

- Material: Brass
- Material: Latón

CODE/CÓDIGO	FINISH/ACABADO	L	ROD THROW ALCANCE DE LA BARRA
5203LA	● Antique Brass/Latón Antiguo	76mm(3")	12mm(1/2")
5203NS	● Satin Nickel/Niquel Satin	76mm(3")	12mm(1/2")
5204NS	● Satin Nickel/Niquel Satin	101mm(4")	22mm(7/8")
5204LA	● Antique Brass/Latón Antiguo	101mm(4")	22mm(7/8")
5206NS	● Satin Nickel/Niquel Satin	152mm(6")	22mm(7/8")

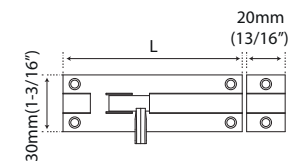

BARREL SURFACE BOLT

PASADOR

CHARACTERISTICS / CARACTERÍSTICAS:

- Rod throw: 1-3/16"
- Material: Brass
- Alcance de la barra: 30mm
- Material: Latón

CODE/CÓDIGO	FINISH/ACABADO
5306NS	● Satin Nickel/Niquel Satin

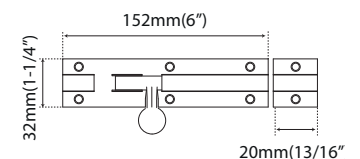

BARREL SURFACE BOLT

PASADOR REDONDO



CHARACTERISTICS / CARACTERÍSTICAS:

- Rod throw: 15/16" • Alcance de la barra: 24mm
- Material: Brass • Material: Latón

CODE/CÓDIGO	FINISH/ACABADO	L
9504R	● Satin Nickel/Niquel Satin	101mm(4")
9506R	● Satin Nickel/Niquel Satin	152mm(6")
9508R	● Satin Nickel/Niquel Satin	203mm(8")

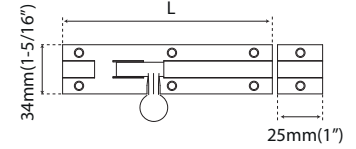

CONCEALED DOOR BOLT

PASADOR DE EMBUTIR OCULTO

CHARACTERISTICS / CARACTERÍSTICAS:

- Rod throw: 30mm(1-3/16") • Alcance de la barra: 30mm(1-3/16")
- Material: Aluminum • Material: Aluminio

CODE/CÓDIGO	FINISH/ACABADO
PT-000749	● Aluminum/Aluminio
PT-000749NE	● Black/Negro

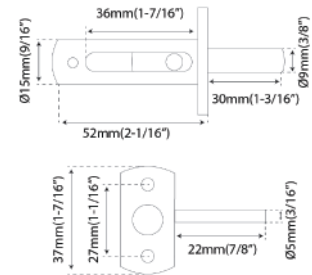

DOOR BALL CATCH

RESBALÓN

CHARACTERISTICS / CARACTERÍSTICAS:

- Material: Stainless Steel 304 • Material: Acero Inoxidable 304

CODE/CÓDIGO	FINISH/ACABADO
WBC002	● Satin

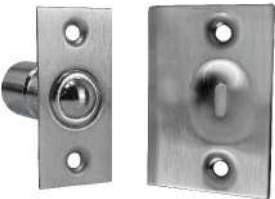
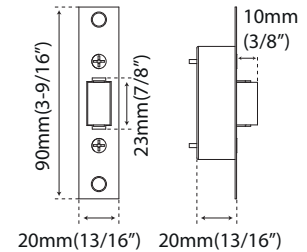

DOOR BALL CATCH

RESBALÓN BALA

CHARACTERISTICS / CARACTERÍSTICAS:

- Material: Stainless Steel 304 • Material: Acero Inoxidable 304

CODE/CÓDIGO	FINISH/ACABADO
RJ001SN	● Satin

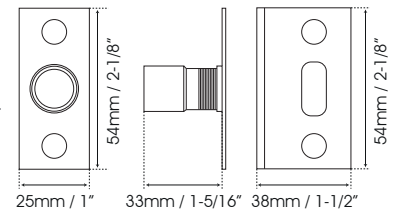

ROLLER CATCH

RESBALÓN

CHARACTERISTICS / CARACTERÍSTICAS:

- Material: Stainless Steel 304 • Material: Acero Inoxidable 304

CODE/CÓDIGO	FINISH/ACABADO
RJ003SS	● Satin

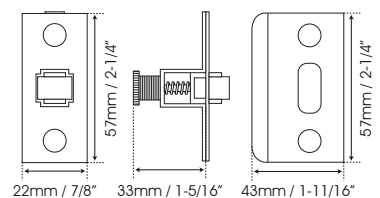



HOOKED SURFACE BOLT

PASADOR PARA PUERTA CORREDIZA

CHARACTERISTICS / CARACTERÍSTICAS:

20/200

- Ideal for aluminum and wood sliding doors
- Ideal para puertas correderas de aluminio y madera.
- Material: Stainless Steel 304
- Material: Acero Inoxidable 304

CODE/CÓDIGO	FINISH/ACABADO
DB-001	● Satin
DB-001N	● Black / Negro

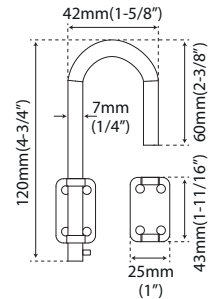

HOOK AND EYE

GANCHO

CHARACTERISTICS / CARACTERÍSTICAS:

10/200

- Surface mount
- Montaje en la puerta
- Material: Stainless Steel 304
- Material: Acero Inoxidable 304

CODE/CÓDIGO	FINISH/ACABADO
WG103	● Satin

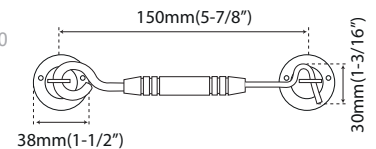

SWIVEL HOOK AND EYE

GANCHO

CHARACTERISTICS / CARACTERÍSTICAS:

10/200

- Surface Mount
- Montaje en la puerta
- Material: Brass
- Material: Latón

CODE/CÓDIGO	FINISH/ACABADO	L
6522-2NS	● Satin Nickel/Niquel Satin	50mm(2")
6523-3NS	● Satin Nickel/Niquel Satin	60mm(2-3/8")
6524-4NS	● Satin Nickel/Niquel Satin	75mm(2-15/16")
6522-2ORB	● Black/Negro	50mm(2")
6522-2SB	● Matte Brass/Latón Mate	50mm(2")

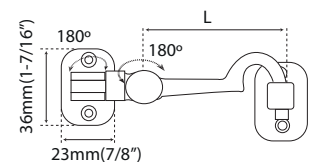

HOOK AND EYE

GANCHO

CHARACTERISTICS / CARACTERÍSTICAS:

10

- Surface mount
- Montaje en la puerta
- Material: Brass
- Material: Latón

CODE/CÓDIGO	FINISH/ACABADO	L
6516-6LA	● Antique Brass/Latón Antiguo	152mm(6")
6516-6LP	● Polished Brass/Latón Pulido	152mm(6")
6518-8LA	● Antique Brass/Latón Antiguo	203mm(8")
6518-8NS	● Satin Nickel/Niquel Satin	203mm(8")

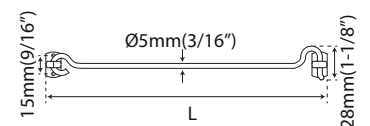



SLIDING LATCH BOLT

PASADOR PORTA CANDADO

CHARACTERISTICS / CARACTERÍSTICAS:

- Rod throw: 3-1/8" • Alcance de la barra: 80mm
- Material: Stainless Steel 304 • Material: Acero Inoxidable 304

CODE/CÓDIGO	FINISH/ACABADO
DA-1901-10	● Satin

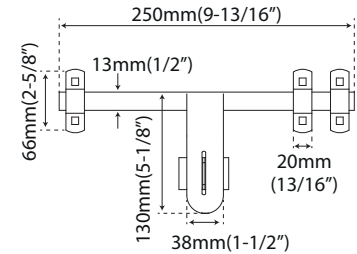

Padlock hole/
Orificio para candado
Ø15mm (9/16")



SECURITY LATCH HASP BARREL BOLT

PASADOR PORTACANDADO

CHARACTERISTICS / CARACTERÍSTICAS:

- For use on gates • Alcance de la barra: 45mm
- Rod throw: 1-3/4" • Material: Acero Inoxidable 304
- Material: Stainless Steel 304

CODE/CÓDIGO	FINISH/ACABADO
FT-6138	● Satin

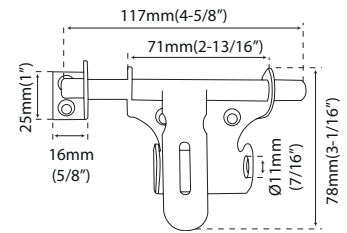

Padlock hole/
Orificio para candado
Ø11mm (7/16")

SAFETY HASP

PORTACANDADO

CHARACTERISTICS / CARACTERÍSTICAS:

- Surface mount • Montaje en la puerta y marco
- All screws conceal when closed • Todos los tornillos se ocultan cuando están cerrados
- Heavy Duty • Uso Rudo
- Material: Brass • Material: Latón

CODE/CÓDIGO	FINISH/ACABADO	A	B
65572X1NS	● Satin Nickel/Niquel Satin	51mm (2")	15mm (9/16")
65582.12X1NS	● Satin Nickel/Niquel Satin	63.5mm (2-1/2")	22mm (7/8")
65593X1NS	● Satin Nickel/Niquel Satin	76mm (3")	22mm (7/8")
65604X1NS	● Satin Nickel/Niquel Satin	102mm (4")	20mm (13/16")

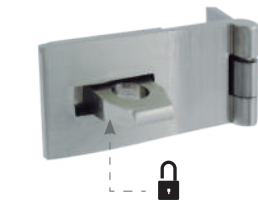
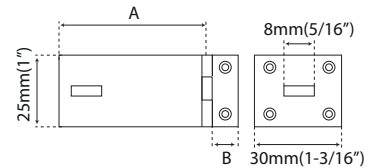

Padlock hole/
Orificio para candado
Ø8mm (5/16")

SAFETY HASP

PORTACANDADO

CHARACTERISTICS / CARACTERÍSTICAS:

- Surface mount • All screws conceal when closed • Montaje en la puerta y el marco
- Material: Stainless Steel 304 • Includes staple • Material: Acero Inoxidable 304

CODE/CÓDIGO	FINISH/ACABADO	A	B	C	D	E
CMHK001	● Satin	19mm (3/4")	55mm (2-3/16")	15mm (9/16")	16mm (5/8")	20mm (13/16")
CMHK002	● Satin	21mm (13/16")	65mm (2-9/16")	16mm (5/8")	16mm (5/8")	20mm (13/16")
CMHK003	● Satin	24mm (15/16")	72mm (2-13/16")	16mm (5/8")	16mm (5/8")	20mm (13/16")
CMHK004	● Satin	31mm (1-1/4")	94mm (3-11/16")	23mm (7/8")	23mm (7/8")	30mm (1-3/16")
CMHK005	● Satin	35mm (1-3/8")	104mm (4-1/8")	22mm (7/8")	23mm (7/8")	30mm (1-3/16")
CMHK006	● Satin	40mm (1-9/16")	76mm (3")	45mm (1-3/4")	45mm (1-3/4")	35mm (1-3/8")
CMHK007	● Satin	40mm (1-9/16")	100mm (3-15/16")	45mm (1-3/4")	45mm (1-3/4")	35mm (1-3/8")
CMHK008	● Satin	40mm (1-9/16")	127mm (5")	45mm (1-3/4")	45mm (1-3/4")	35mm (1-3/8")

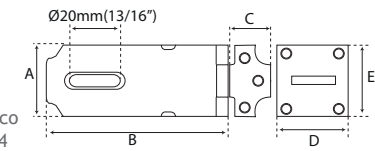

Padlock hole/
Orificio para candado
Ø20mm (13/16")

KEYED SAFETY HASP

PORTACANDADO CON LLAVE

CHARACTERISTICS / CARACTERÍSTICAS:

- Surface mount • Montaje en la puerta y el marco
- 2 keys included • Incluye 2 llaves
- Suitable for indoor/outdoor use • Adecuado para uso interior / exterior
- Material: Steel • Material: Acero

CODE/CÓDIGO	FINISH/ACABADO	A	B	C
FT-9514	● Satin Nickel/Niquel Satin	80mm (3-1/8")	65mm (2-9/16")	32mm (1-1/4")
FT-9515	● Satin Nickel/Niquel Satin	90mm (3-9/16")	78mm (3-1/16")	32mm (1-1/4")
FT-9516	● Satin Nickel/Niquel Satin	120mm (4-3/4")	100mm (4")	40mm (1-9/16")
FT-9517	● Satin Nickel/Niquel Satin	142mm (5-9/16")	115mm (4-1/2")	40mm (1-9/16")

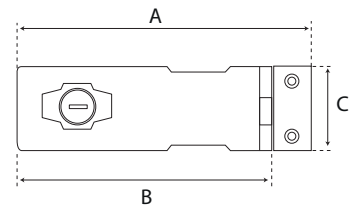



WEATHER STRIPPING BURLETES

ADHESIVE FOAM WEATHER STRIPPING

BURLETE ESPUMA ADHESIVO



CHARACTERISTICS / CARACTERÍSTICAS:



- 32'
- Fixation with 3M Adhesive
- Use on doors and windows
- Ideal for installation on PVC, aluminum and wood supports
- Insulates from heat, cold, noise and dust
- 10 metros
- Adhesivo 3M
- Uso en puertas y ventanas
- Ideal para instalar en soportes de PVC, aluminio y madera
- Aísla del calor, frío, ruido y polvo

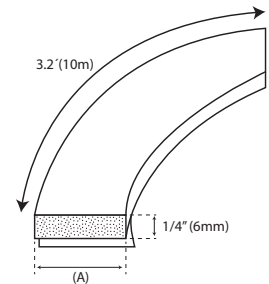

CODE/CÓDIGO	FINISH/ACABADO	MEASURE / MEDIDA (A)
14413	○ White/Blanco	3/8" 9mm
14414	○ White/Blanco	1/2" 12mm
14415	○ White/Blanco	9/16" 15mm

WEATHER STRIPPING MOD. 2

BURLETE MOD.2

CHARACTERISTICS / CARACTERÍSTICAS:



- Material: Aluminum and plush
- Fixation with 3M Adhesive
- Help remove existing slot between the floor and the door keeps out dust, noise, heat, cold, insects, and more.
- Material: Aluminio y felpa
- Adhesivo 3M
- Ayuda a eliminar la ranura existente entre el piso y la puerta para evitar el polvo, el ruido, el calor, el frío, los insectos y más.



CODE/CÓDIGO	FINISH/ACABADO	MEASURE	MEDIDA
2051	○ White/Blanco	32"	820mm
2075	● Silver/Plata	32"	820mm
2055	○ White/Blanco	39"	1 metro
2056	● Bronze/Bronce	39"	1 metro
2076	● Silver/Plata	39"	1 metro

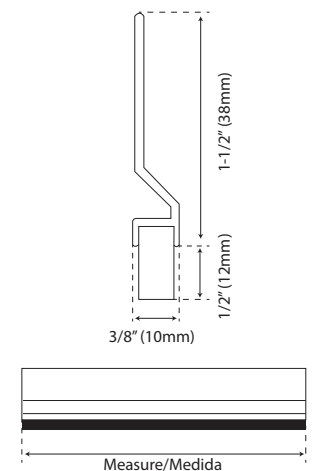

DRAUGHT EXCLUDER MOD. 14

BURLETE SOBREPONER MOD.14



CHARACTERISTICS / CARACTERÍSTICAS:

10/100

- Fixation with 3M Adhesive
- For wooden doors
- Protection against dust, noise and drafts
- Adhesivo 3M
- Para puerta de madera
- Protección contra polvo, ruido y corrientes de aire

CODE/CÓDIGO	FINISH/ACABADO	MEASURE	MEDIDA
BUR884B	○ White/Blanco	39"	1 metro
BUR887B	● Bronze/Bronce	39"	1 metro
BUR893B	● Silver/Plata	39"	1 metro

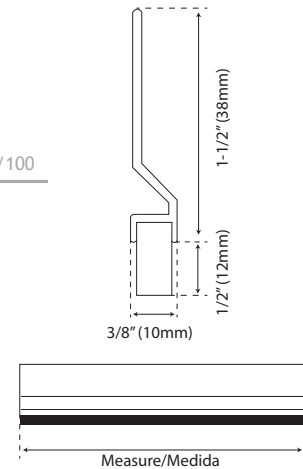

DRAUGHT EXCLUDER MOD. 16

BURLETE DE SOBREPONER MOD.16



CONCEALED ADAPTABLE TO THE FLOOR /
OCULTO AUTONIVELABLE

CHARACTERISTICS / CARACTERÍSTICAS:

4/20

- Material: Aluminum
- It can be shortened up to 200mm on the extremity opposite the adjusting button
- Automatic opening and closing
- Automatic closing covering up to 11/16" depth
- Easy installation
- Mainly applied to wooden, aluminum and armoured doors
- Material: Aluminio
- Posibilidad de cortar a 200mm en la parte contraria al tope de ajuste
- Apertura y cierra automáticos
- Cierra automáticamente al hueco entre la puerta y el pavimento con una abertura máx de 18mm
- Fácil instalación
- Aplicable en puertas de madera, aluminio y acorazadas

CODE/CÓDIGO	FINISH/ACABADO	MEASURE	MEDIDA
BUR5161012	● Silver/Plata	39"	1 metro
BUR516103	● Bronze/Bronce	39"	1 metro
BUR516108	○ White/Blanco	39"	1 metro

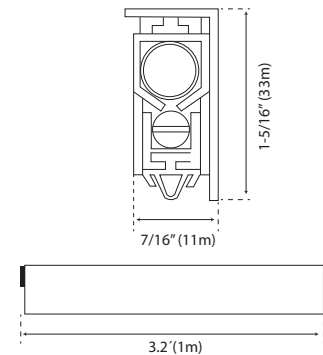

CONCEALED WEATHER STRIPING MOD. 517

BURLETE OCULTO MOD. 517



CHARACTERISTICS / CARACTERÍSTICAS:

4/20

- **Material:** Aluminum
- Autoself closing
- Including elastic rubber, brass adjusting screws, nickel steel rivets
- Automatic closing covering up to 11/16" depth
- Easy installation
- Inside profile with a basculant movement
- Mainly applied to wooden, aluminum and armoured door
- **Material:** Aluminio
- Auto cierre
- Incluye goma elástica y levas en acero inoxidable, tornillo de regulación en latón y placas en acero niquelado
- Cierra automáticamente el hueco entre la puerta y el pavimento con una apertura máx de 18mm
- Fácil instalación
- Movimiento basculante del perfil interno
- Aplicable en puertas de madera y acorazadas

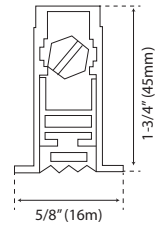

CODE/CÓDIGO	FINISH/ACABADO	MEASURE	MEDIDA
BUR5171010	● Matte Chrome / Cromo Mate	39"	1 metro

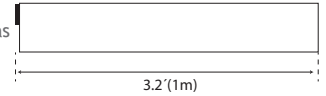

DOOR BOTTOM WEATHER SETS MOD. 504

BURLETE DE EMBUTIR MOD. 504



CONCEALED AUTOMATIC ADAPTABLE TO THE FLOOR HEAVY DUTY /
OCULTO, AUTOMÁTICO AUTONIVELABLE REFORZADO

CHARACTERISTICS / CARACTERÍSTICAS:

4/20

- **Material:** Aluminum
- Including elastic rubber, brass adjusting screws, nickel steel rivets and stainless steel springs and levers
- Automatic closing covering up to 11/16" depth
- Easy installation
- Inside profile with a basculant movement
- Mainly applied to wooden, aluminum and armoured doors
- It can be shortened up to 200mm on the extremity opposite the adjusting button
- **Material:** Aluminio
- Incluye goma elástica, muelle y levas en acero inoxidable, tornillo de regulación en latón y placas en acero niquelado
- Cierra automáticamente el hueco entre la puerta y el pavimento con una apertura máx de 18mm
- Fácil instalación
- Movimiento basculante del perfil interno
- Aplicable en puertas de madera, aluminio y acorazadas
- Posibilidad de corte a 200mm en la parte contraria al botón de ajuste

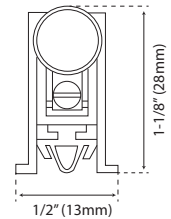

CODE/CÓDIGO	FINISH/ACABADO	MEASURE	MEDIDA
504-100MHA	● Silver/Plata	39"	1 metro

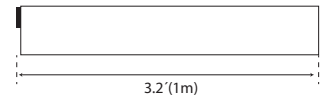

DOOR BOTTOM WEATHER SETS MOD. 503

BURLETE DE EMBUTIR MOD. 503



CONCEALED AUTOMATIC ADAPTABLE TO THE FLOOR /
OCULTO, AUTOMÁTICO AUTONIVELABLE

CHARACTERISTICS / CARACTERÍSTICAS:

5/20

- **Material:** Aluminum
- Automatic closing covering up to 11/16" depth
- Self-directional pin joint with a 1/8" hexagonal wrend (to avoid the instalation of the plate againts crushing)
- Easy installation thanks to the preassembled screws accesible after shipping off the gasket
- Inside profile with a basculant movement
- Mainly applied to wooden, aluminum and armoured doors
- It can be shortened up to 200mm on the extremity opposite the adjusting button
- **Material:** Aluminio
- Cierra automáticamente el hueco entre la puerta y el pavimento con una apertura máx de 18mm
- Botón autoregulable con llave hexagonal de 3mm (evita la instalación de la placa en el marco)
- Fácil instalación debido a los tornillos premontados disponibles tras el desplazamiento de la goma
- Movimiento basculante del perfil interno
- Aplicable en puertas de madera, aluminio y acorazadas
- Posibilidad de corte a 200mm en la parte contraria al botón de ajuste

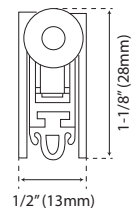

CODE/CÓDIGO	FINISH/ACABADO	MEASURE	MEDIDA
503-120MHA	● Silver/Plata	3.9'	1.2 metros

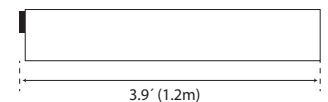

CONCEALED WEATHER STRIPING MOD. 1

BURLETE OCULTO MOD. 1



CHARACTERISTICS / CARACTERÍSTICAS:

2

- Automatic inlay weatherstripping
- Rubber closure
- Stainless steel inner mechanism and brass stop
- Invisible
- Self-leveling
- Burlete automático de embutir
- Cierre de goma
- Mecanismo interior de acero inoxidable y tope de latón
- Invisible
- Autonivelable

CODE/CÓDIGO	FINISH/ACABADO	MEASURE	MEDIDA
BURLETE1	● Silver/Plata	3.2'	1 metro

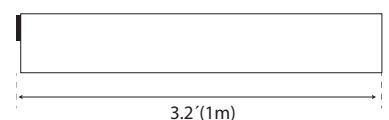
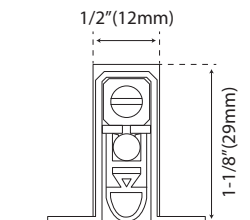

All measurements are approximate / Las medidas son aproximadas



SELF-STICK WEATHERSEAL

SELLO PERIMETRAL DE PLÁSTICO

CHARACTERISTICS / CARACTERÍSTICAS:

- Material: Plastic
- Auto-adhesive (3M)
- Ideal for inside the door
- Protection against dust, noise and drafts

- Material: Plástico
- Auto-Adherible (3M)
- Ideal para el interior de la puerta
- Protección contra polvo, ruido y corrientes de aire

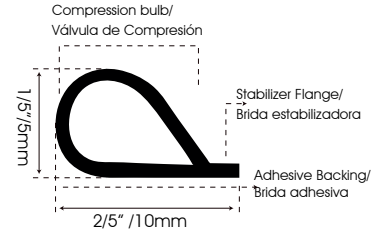

CODE/CÓDIGO	FINISH/ACABADO	GRILL/FIJACIÓN	MEASURE	MEDIDA
SPJ-B1M	○ WHITE/BLANCO	WITH ADHESIVO 3M	3.2'	1 metro
SPJ-C1M	● BROWN/CAFÉ	WITH ADHESIVO 3M	3.2'	1 metro
SPJ-N1M	● BLACK/NEGRO	WITH ADHESIVO 3M	3.2'	1 metro

SELF-STICK WEATHERSEAL

SELLO PERIMETRAL DE GOMA

CHARACTERISTICS / CARACTERÍSTICAS:

- Material: Rubber
- Auto-adhesive (3M)
- Ideal for inside the door
- Protection against dust, noise and drafts

- Material: Goma
- Auto-Adherible (3M)
- Ideal para el interior de la puerta
- Protección contra polvo, ruido y corrientes de aire

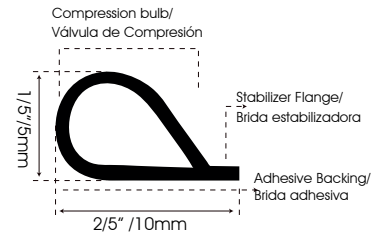

CODE/CÓDIGO	FINISH/ACABADO	GRILL/FIJACIÓN	MEASURE	MEDIDA
SPJ-G	● GREY/GRIS	WITH ADHESIVO 3M	3.2'	1 metro
SPJ-N	● BLACK/NEGRO	WITH ADHESIVO 3M	3.2'	1 metro



SELF-STICK WEATHERSEAL, "D" PROFILE

SELLO PERIMETRAL, PERFIL "D"

CHARACTERISTICS / CARACTERÍSTICAS:

- Material: Rubber Foam
- Auto-adhesive (3M)
- Ideal for inside the door
- Protection against dust, noise and drafts

- Material: Espuma de goma
- Auto-Adherible (3M)
- Ideal para el interior de la puerta
- Protección contra polvo, ruido y corrientes de aire

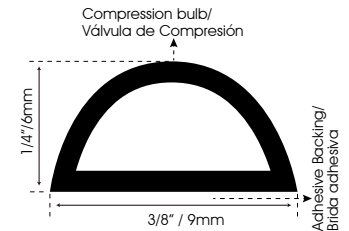

CODE/CÓDIGO	FINISH/ACABADO	GRILL/FIJACIÓN	MEASURE	MEDIDA
SPJB	○ WHITE/BLANCO	WITH ADHESIVO 3M	492'	150 metros
SPJC	● BROWN/CAFÉ	WITH ADHESIVO 3M	492'	150 metros
SPJN	● BLACK/NEGRO	WITH ADHESIVO 3M	492'	150 metros





AUTOMATIC SPRING LOADED BOLT LATCH

ALDABA CON RESORTE

CHARACTERISTICS / CARACTERÍSTICAS:

10/100

- Surface mount
- Suitable for doors or windows
- Material: Stainless Steel 304
- Montaje en la puerta
- Adecuado para puertas o ventanas
- Material: Acero Inoxidable 304

CODE/CÓDIGO FINISH/ACABADO

WA110 ● Satin

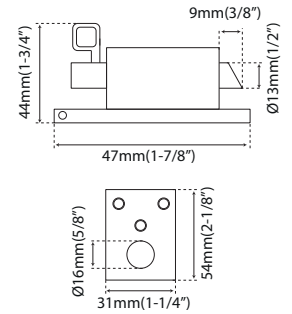

AUTOMATIC SPRING LOADED BOLT LATCH

ALDABA CON RESORTE

CHARACTERISTICS / CARACTERÍSTICAS:

10/100

- Surface mount
- Suitable for doors or windows
- Material: Stainless Steel 304
- Montaje en la puerta
- Adecuado para puertas o ventanas
- Material: Acero Inoxidable 304

CODE/CÓDIGO FINISH/ACABADO

WA111 ● Satin

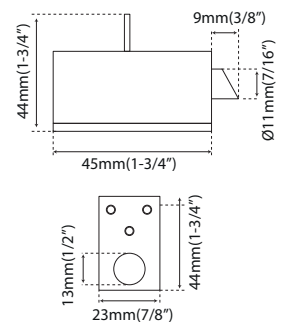

AUTOMATIC SPRING LOADED BOLT LATCH

PASADOR PARA VENTANA

CHARACTERISTICS / CARACTERÍSTICAS:

5

- Surface mount
- Suitable for doors or windows
- Material: Brass
- Montaje en la puerta
- Adecuado para puertas o ventanas
- Material: Latón

CODE/CÓDIGO FINISH/ACABADO

6263LA ● Antique Brass/Latón Antiguo
6263LP ● Polished Brass/Latón Pulido
6263NS ● Satin Nickel/Niquel Satin
6263ORB ● Black/Negro

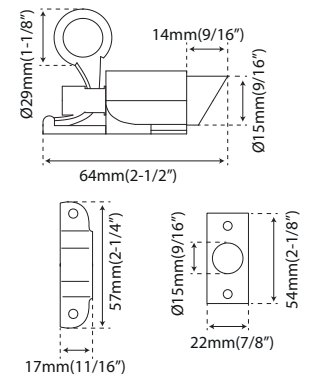

TRADITIONAL METAL LATCH

ALDABA PARA VENTANA

CHARACTERISTICS / CARACTERÍSTICAS:

2/200

- Surface-mount
- Suitable for doors or windows
- Rod throw: 13/16"
- Material: Stainless Steel 304
- Montaje en la puerta
- Adecuado para puertas o ventanas
- Alcance de la barra: 20mm
- Material: Acero Inoxidable 304

CODE/CÓDIGO FINISH/ACABADO

WA112 ● Satin

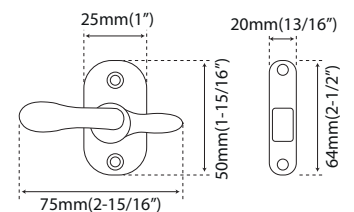

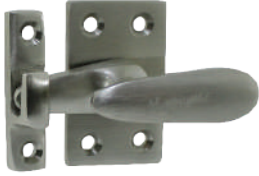

TRADITIONAL METAL LATCH

PASADOR PARA VENTANA

CHARACTERISTICS / CARACTERÍSTICAS:

10/20

- Surface mount
- Suitable for doors or windows
- Rod throw: 11/16"
- Material: Brass
- Montaje en la puerta
- Adecuado para puertas o ventanas
- Alcance de la barra: 17mm
- Material: Latón

CODE/CÓDIGO	FINISH/ACABADO
6261NS	● Satin Nickel/Niquel Satin
6261ORB	● Black/Negro

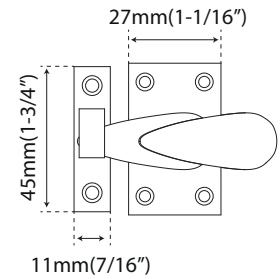

BAR LATCH

ALDABA PARA VENTANA

CHARACTERISTICS / CARACTERÍSTICAS:

10/100

- Surface mount
- Lift and slide
- Ideal for sliding door or gates
- Rod throw: 1-15/16"
- Material: Stainless Steel 304
- Montaje en la puerta
- Levantar y deslizar
- Ideal para Puerta Corrediza
- Alcance de la barra: 50mm
- Material: Acero Inoxidable 304

CODE/CÓDIGO	FINISH/ACABADO	A	B
DG005SSP	● Satin	50mm (1-15/16")	70mm (2-3/4")
DG005SSG	● Satin	70mm (2-3/4")	100mm (3-15/16")

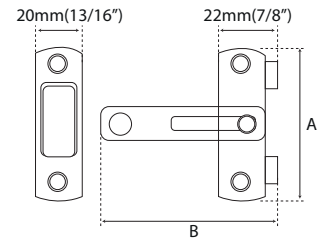

BAR LATCH

ALDABA DECORATIVA

CHARACTERISTICS / CARACTERÍSTICAS:

10

- Surface mount
- Ideal for sliding door or gates
- Rod throw: 22mm (7/8")
- Material: Brass
- Montaje en la puerta
- Levantar y deslizar
- Ideal para Puerta Corrediza
- Alcance de la barra: 22mm (7/8")
- Material de Fabricación: Latón

CODE/CÓDIGO	FINISH/ACABADO
6234LA	● Antique Brass/Latón Antiguo
6234LP	● Polished Brass/Latón Pulido
6234NS	● Satin Nickel/Niquel Satin

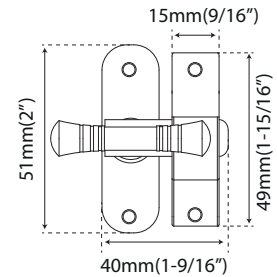

BAR LATCH

ALDABA DECORATIVA

CHARACTERISTICS / CARACTERÍSTICAS:

10

- Ideal for sliding door or gates
- Rod throw: 1-3/4"
- Material: Brass
- Ideal para Puerta Corrediza
- Alcance de la barra: 45mm
- Material: Latón

CODE/CÓDIGO	FINISH/ACABADO
6235NS	● Satin Nickel/Niquel Satin

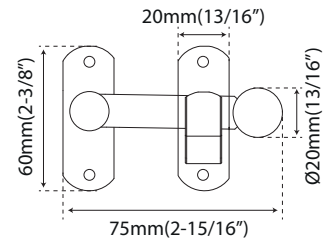

ROTATING WINDOW CASEMENT FASTENER

PASADOR PARA VENTANA

CHARACTERISTICS / CARACTERÍSTICAS:

10

- Suitable for doors or windows
- Rod throw: 10mm (3/8")
- Material: Brass
- Ideal para Puerta Corrediza
- Alcance de la barra: 10mm (3/8")
- Material: Latón

CODE/CÓDIGO	FINISH/ACABADO
6260LP	● Polished Brass/Latón Pulido
6260NS	● Satin Nickel/Niquel Satin

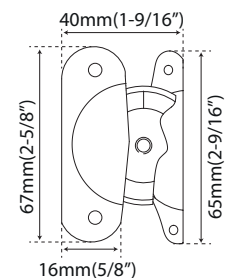



WINDOW CASEMENT FASTENER

ALDABA VICTORIANA

CHARACTERISTICS / CARACTERÍSTICAS:

- Suitable for doors or windows
- Rod throw: 15/16"
- Material: Brass
- Ideal para puertas y ventanas
- Alcance de la barra: 24mm
- Material: Latón

CODE/CÓDIGO FINISH/ACABADO
6253NS ● Satin Nickel/Niquel Satín

4

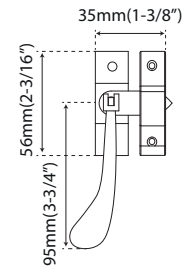

WINDOW CASEMENT FASTENER

PASADOR PARA VENTANA

CHARACTERISTICS / CARACTERÍSTICAS:

- Suitable for doors or windows
- Rod throw: 11/16"
- Material: Brass
- Ideal para puertas y ventanas
- Alcance de la barra: 18mm
- Material: Latón

CODE/CÓDIGO FINISH/ACABADO
6255LA ● Antique Brass/Latón Antiguo
6255NS ● Satin Nickel/Niquel Satín

4

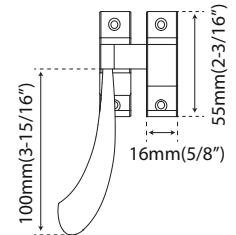

WINDOW CASEMENT FASTENER

PASADOR PARA VENTANA

CHARACTERISTICS / CARACTERÍSTICAS:

- Suitable for doors or windows
- Rod throw: 13/16"
- Material: Brass
- Ideal para puertas y ventanas
- Alcance de la barra: 20mm
- Material: Latón

CODE/CÓDIGO FINISH/ACABADO
6256LP ● Polished Brass/Latón Pulido
6256NS ● Satin Nickel/Niquel Satín

4

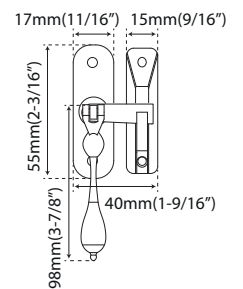

WINDOW CASEMENT STAY

PROYECTOR PARA VENTANA

CHARACTERISTICS / CARACTERÍSTICAS:

- Features locking mechanism
- Allows windows to remain open
- Swivel bracket
- Material: Stainless Steel 304
- Con mecanismo de bloqueo
- Permite que las ventanas permanezcan abiertas
- Soporte giratorio
- Material: Acero Inoxidable 304

CODE/CÓDIGO FINISH/ACABADO
WP101 ● Satin

10/100

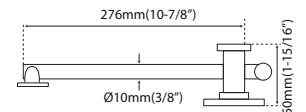

WINDOW FRAME/MARCO DE LA VENTANA

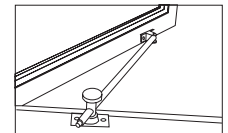

WINDOW CASEMENT STAY

PROYECTOR PARA VENTANA

CHARACTERISTICS / CARACTERÍSTICAS:

- Features locking mechanism
- Allows windows to remain open
- Swivel bracket
- Material: Brass
- Con mecanismo de bloqueo
- Permite que las ventanas permanezcan abiertas
- Soporte giratorio
- Material: Latón

CODE/CÓDIGO FINISH/ACABADO
6221LA ● Antique Brass/Latón Antiguo
6221LP ● Polished Brass/Latón Pulido
6221NS ● Satin Nickel/Niquel Satín
6221ORB ● Black/Negro

10

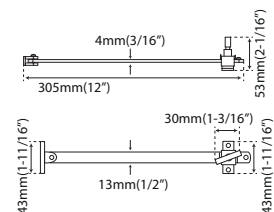

WINDOW FRAME/MARCO DE LA VENTANA

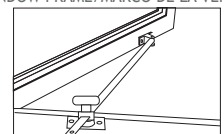

BATHROOM PARTITIONS

HERRAJES PARA MAMPARAS

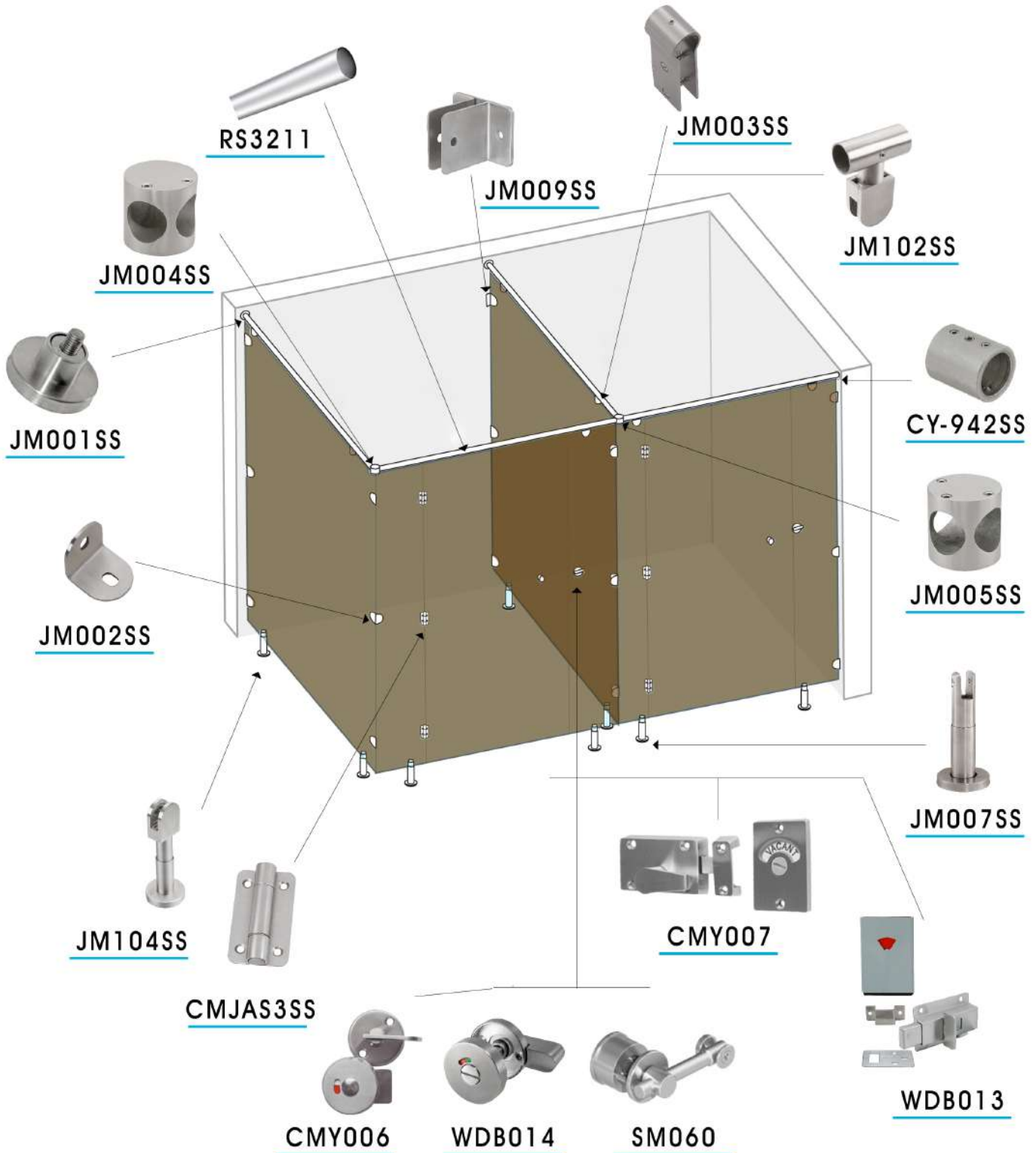



SLIDE LATCH WITH INDICATOR

MULETILLA CON INDICADOR

CHARACTERISTICS / CARACTERÍSTICAS:

- Door thickness: 1-1/16" - 2-1/4"
- Rod throw: 13/16"
- Material: Stainless Steel 304
- Espesor de la puerta: 27-57mm
- Alcance de desplazamiento: 20mm
- Material: Acero Inoxidable 304

CODE/CÓDIGO	FINISH/ACABADO	INDICATOR	INDICADOR
CMY007	● Satin	Engaged / Vacant	Ocupado / Vacío

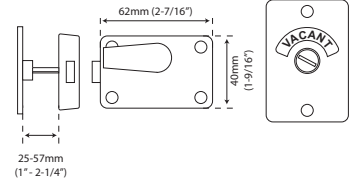

SLIDE LATCH COLOR INDICATOR

MULETILLA CON INDICADOR

CHARACTERISTICS / CARACTERÍSTICAS:

- Door thickness: 13/16" - 1-5/16"
- Rod throw: 13/16"
- Material: Stainless Steel 304
- Espesor de la puerta: 20-34mm
- Alcance de desplazamiento: 20mm
- Material: Acero Inoxidable 304

CODE/CÓDIGO	FINISH/ACABADO	INDICATOR	INDICADOR
WDB013	● Satin	Blue / Red	Azul/Rojo

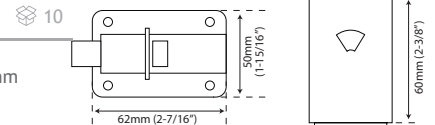

THROW LATCH WITH COLOR INDICATOR

MULETILLA REDONDA CON INDICADOR

CHARACTERISTICS / CARACTERÍSTICAS:

- Door thickness: 3/8" - 1-1/16"
- Rod throw: 7/8"
- Material: Stainless Steel 304
- Espesor de la puerta: 9-30mm
- Alcance de desplazamiento: 23mm
- Material: Acero Inoxidable 304

CODE/CÓDIGO	FINISH/ACABADO	INDICATOR	INDICADOR
WDB014	● Satin	Green / Red	Verde/Rojo

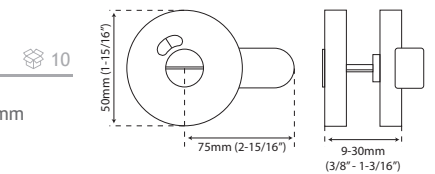

THROW LATCH WITH COLOR INDICATOR

MULETILLA REDONDA CON INDICADOR

CHARACTERISTICS / CARACTERÍSTICAS:

- Door thickness: 3/8" - 1-3/4"
- Rod throw: 16mm (5/8")
- Material: Stainless Steel 304
- Espesor de la puerta: 9-45mm
- Alcance de desplazamiento: 16mm
- Material: Acero Inoxidable 304

CODE/CÓDIGO	FINISH/ACABADO	INDICATOR	INDICADOR
CMY006	● Satin	Green / Red	Verde/Rojo

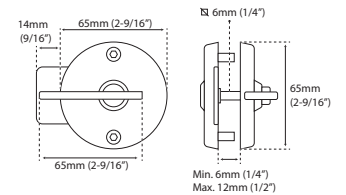

THROW LATCH WITH INDICATOR

MULETILLA CON INDICADOR

CHARACTERISTICS / CARACTERÍSTICAS:

- Door thickness: 1/2" - 13/16"
- Rod throw: 1-1/8"
- Material: Stainless Steel 304
- Espesor de la puerta: 12-20mm
- Alcance de desplazamiento: 28mm
- Material: Acero Inoxidable 304

CODE/CÓDIGO	FINISH/ACABADO	INDICATOR	INDICADOR
SM060	● Satin	Green / Red	Verde/Rojo

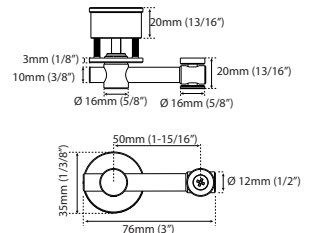

SUPPORT HINGE

BISAGRA DE RESORTE

CHARACTERISTICS / CARACTERÍSTICAS:

- Material: Stainless Steel 304
- Material: Acero Inoxidable 304

CODE/CÓDIGO	FINISH/ACABADO
CMJAS3SS	● Satin

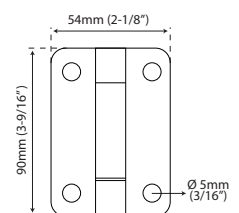



ANCHORING SUPPORTS

SOPORTE PARA MAMPARA

CHARACTERISTICS / CARACTERÍSTICAS:

- Material: Stainless Steel 304
- Material: Acero Inoxidable 304

CODE/CÓDIGO	FINISH/ACABADO		
JM001SS	● Satin	Lateral	Brida para tubo 1"
JM003SS	● Satin	Hanging	Soporte para mampara
JM007SS	● Satin	Floor	Soporte de pie

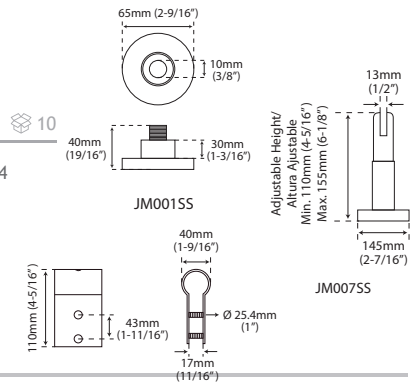

ANCHORING BRACKET

SOPORTE PARA MAMPARA

CHARACTERISTICS / CARACTERÍSTICAS:

- Material: Stainless Steel 304
- Material: Acero Inoxidable 304

CODE/CÓDIGO	FINISH/ACABADO		
JM009SS	● Satin	"T" Support	Soporte "T"
JM002SS	● Satin	Support Bracket	Soporte en escuadra

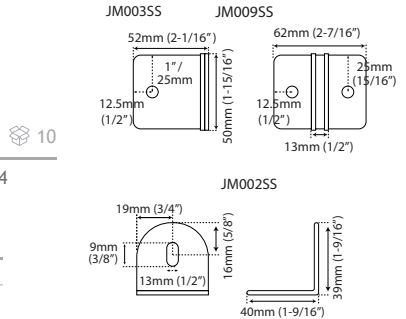

ANCHORING SUPPORTS

SOPORTE PARA MAMPARA

CHARACTERISTICS / CARACTERÍSTICAS:

- Material: Stainless Steel 304
- Material: Acero Inoxidable 304

CODE/CÓDIGO	FINISH/ACABADO		
JM102SS	● Satin	Hanging	Soporte para mampara
JM104SS	● Satin	Floor	Soporte de pie

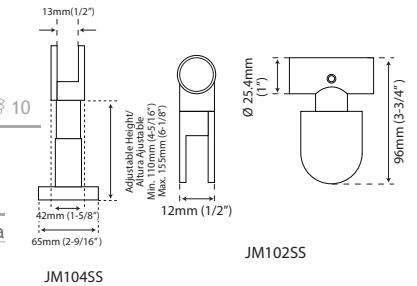

CONNECTORS

CONECTOR

CHARACTERISTICS / CARACTERÍSTICAS:

- For 1" tubing
- Material: Stainless Steel 304
- Para tubo de 25mm
- Material: Acero Inoxidable 304

CODE/CÓDIGO	FINISH/ACABADO		
JM004SS	● Satin	2 holes	Para dos tubos
JM005SS	● Satin	3 holes	Para tres tubos

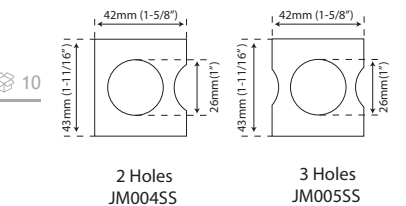

LATERAL WALL CONNECTOR

CONECTOR LATERAL A MURO

CHARACTERISTICS / CARACTERÍSTICAS:

- Material: Solid Stainless Steel 304
- Material: Acero Inoxidable Sólido 304

CODE/CÓDIGO	FINISH/ACABADO
CY-924SS	● Satin

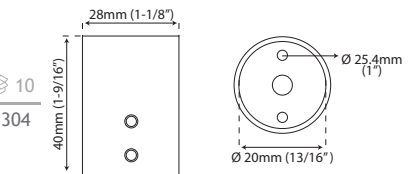

TUBULAR BAR

TUBO REDONDO

CHARACTERISTICS / CARACTERÍSTICAS:

- Thick .8 (1/32")
- Material: Stainless Steel 304
- Espesor de .8 (1/32")
- Material: Acero Inoxidable 304

CODE/CÓDIGO	FINISH/ACABADO	
RS32112508-2	● Satin	6.56' (2mt)
RS32112508-3	● Satin	9.84' (3mt)



BATHROOM PARTITIONS

HERRAJES PARA MAMPARAS

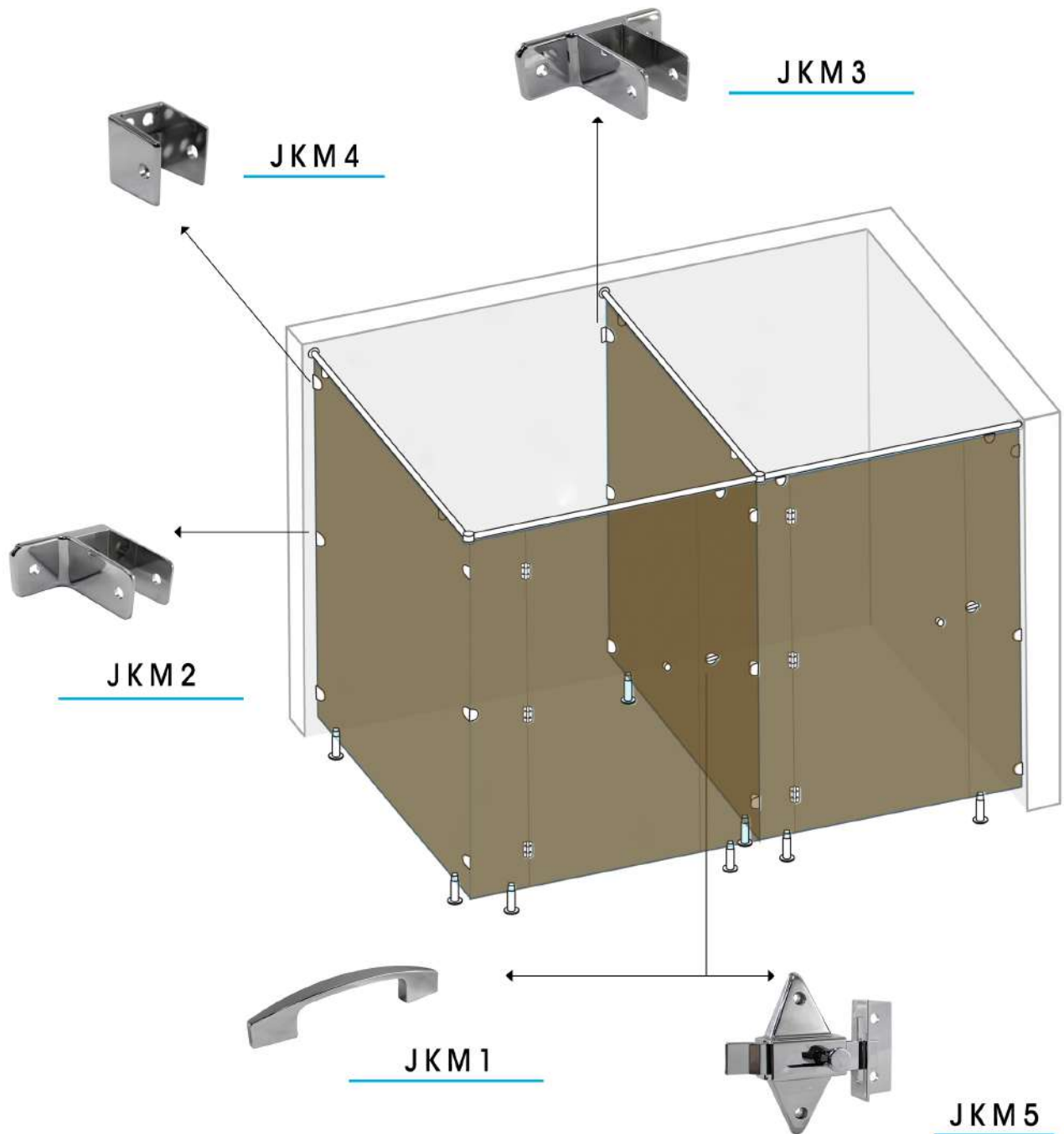



DOOR PULL HANDLE

JALADERA PARA PUERTA DE MAMPARA DE BAÑO

CHARACTERISTICS / CARACTERÍSTICAS:

- Material: Zinc Alloy
- Material: Zamak

CODE/CÓDIGO FINISH/ACABADO
JKM1 Chrome/Brillo

10

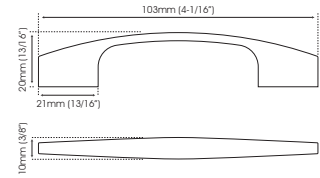

1 EAR PANEL BRACKET 1"

SOPORTE PARA MAMPARA

CHARACTERISTICS / CARACTERÍSTICAS:

- Material: Zinc Alloy
- Material: Zamak

CODE/CÓDIGO FINISH/ACABADO
JKM2 Chrome/Brillo

10

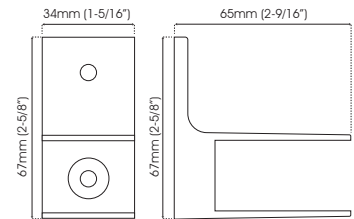

2 EAR PANEL BRACKET 1"

SOPORTE PARA MAMPARA

CHARACTERISTICS / CARACTERÍSTICAS:

- Material: Zinc Alloy
- Material: Zamak

CODE/CÓDIGO FINISH/ACABADO
JKM3 Chrome/Brillo Separador de dos orejas 1"

10

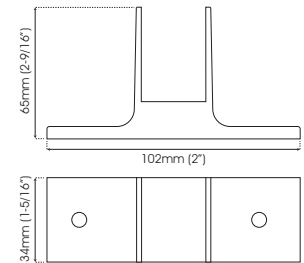

"U" PANEL BRACKET 1"

SOPORTE PARA MAMPARA

CHARACTERISTICS / CARACTERÍSTICAS:

- Material: Zinc Alloy
- Material: Zamak

CODE/CÓDIGO FINISH/ACABADO
JKM4 Chrome/Brillo Separador pilastra de 1"

10

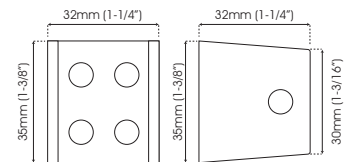

DIAMOND SLIDE BOLT LATCH

PASADOR

CHARACTERISTICS / CARACTERÍSTICAS:

- Material: Zinc Alloy
- Material: Zamak

CODE/CÓDIGO FINISH/ACABADO
JKM5 Chrome/Brillo
JKM5N Black/Negro

10

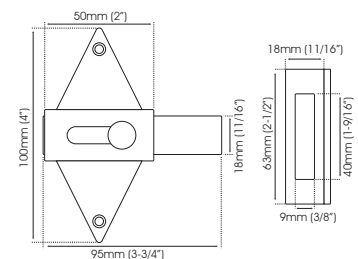



MOD. CURVE

BUZÓN CURVO

CHARACTERISTICS / CARACTERÍSTICAS:

1/12

- Includes 2 keys
- Capacity: Letters only
- Sleek modern design
- Prevents mail from being removed/replaced
- Material: Stainless Steel 304

- Incluye 2 llaves
- Capacidad: Carta
- Diseño moderno y elegante
- Evita que el correo sea eliminado / reemplazado
- Material: Acero Inoxidable 304

CODE/CÓDIGO FINISH/ACABADO
BJ01 ● Satin

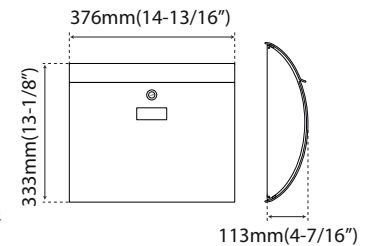

MOD. BUBBLES

BUZÓN BURBUJAS

CHARACTERISTICS / CARACTERÍSTICAS:

1/4

- Includes 2 keys
- Capacity: Letters only
- Sleek modern design
- Prevents mail from being removed/replaced
- Material: Steel

- Incluye 2 llaves
- Capacidad: Carta
- Diseño moderno y elegante
- Evita que el correo sea eliminado / reemplazado
- Material: Acero

CODE/CÓDIGO FINISH/ACABADO
BJ03 ● Grey/Gris

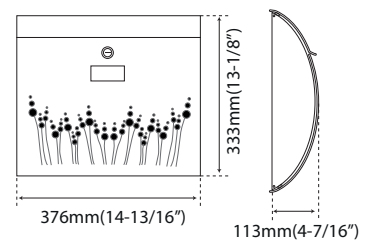

MOD. FLOWER

BUZÓN FLORES

CHARACTERISTICS / CARACTERÍSTICAS:

1/4

- Includes 2 keys
- Capacity: Letters only
- Sleek modern design
- Prevents mail from being removed/replaced
- Material: Steel

- Incluye 2 llaves
- Capacidad: Carta
- Diseño moderno y elegante
- Evita que el correo sea eliminado / reemplazado
- Material: Acero

CODE/CÓDIGO FINISH/ACABADO
BJ04 ● Grey/Gris

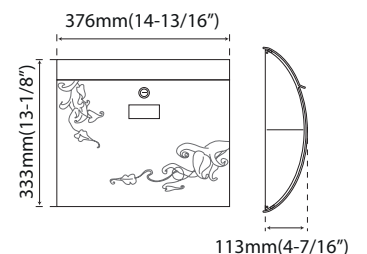



MOD. NANO

BUZÓN NANO

CHARACTERISTICS / CARACTERÍSTICAS:

1/12

- Includes 2 keys
 - Strong and sturdy
 - Capacity: Letters only
 - Sleek modern design
 - Prevents mail from being removed/replaced
 - Material: Stainless Steel 304
- Incluye 2 llaves
 - Capacidad: Carta
 - Diseño moderno y elegante
 - Evita que el correo sea eliminado/reemplazado
 - Material: Acero Inoxidable 304

CODE/CÓDIGO	FINISH/ACABADO
BJ02	● Satin

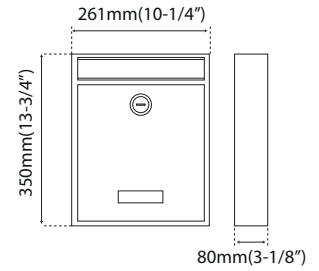

BOX GRID

BUZÓN GRID MAX

CHARACTERISTICS / CARACTERÍSTICAS:

1/5

- Includes 2 keys
 - Strong and sturdy
 - Capacity: letters only
 - Sleek modern design
 - Prevents mail from being removed/replaced
 - Material: Stainless Steel 304
- Incluye 2 llaves
 - Capacidad: Carta
 - Diseño moderno y elegante
 - Evita que el correo sea eliminado/reemplazado
 - Material: Acero Inoxidable 304

CODE/CÓDIGO	FINISH/ACABADO	A	B
BJ05	● Satin	400mm(15-3/4")	256mm(10-1/16")
BJ06	● Satin	370mm(14-9/16")	367mm(14-7/16")

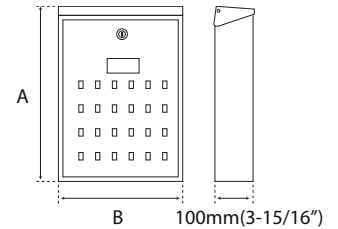

LOCK BOX

PORTALLAVES PARED DE COMBINACIÓN

CHARACTERISTICS / CARACTERÍSTICAS:

1/10

- Ideal for vacation rental
 - Perfect for the storage of keys
 - Secured by a dial combination lock with 4 digits means
 - No need for batteries
 - Can be secured indoor our outdoor as the unit is weatherproof
 - Material: Zinc Alloy
- Ideal para rentas vacacionales
 - Perfecto para el almacenamiento de llaves
 - Asegurado por un bloqueo de combinación de 4 dígitos
 - No necesita batería
 - Se puede colocar en interiores o exteriores ya que la unidad es resistente a la interperie
 - Material: Zamak

CODE/CÓDIGO	FINISH/ACABADO	A	B	C	D	E
JKS004	● Grey/Gris	87mm	120mm	40mm	92mm	128mm
JKS003	● Grey/Gris	105mm	145mm	53mm	120mm	167mm

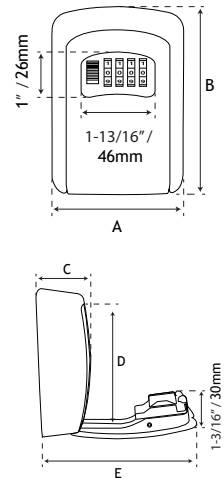

LOCK BOX
IDEAL FOR VACATION RENTAL





KEY CABINET

PORTALLAVES

CHARACTERISTICS / CARACTERÍSTICAS:

1/12

- 3-digit combination
- Material: Steel
- Combinación de 3 dígitos
- Material: Acero

CODE/CÓDIGO	FINISH/ACABADO	CAPACITY OF KEYS/CAPACIDAD DE LLAVES
DKC48	● Black/Negro	48

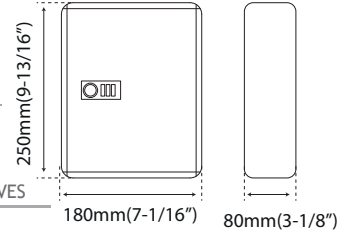

SOLD SEPARATELY 200 pieces
 • Box Key Tags with metal ring different colors
 • Material: Plastic with metal ring

SE VENDEN POR SEPARADO 200 piezas
 • Caja Llaveros Porta Etiquetas Diferentes Colores
 • Material: Plástico con anillo de metal

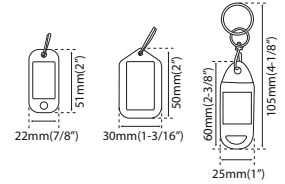

ELECTRONIC KEY CABINET

PORTALLAVES DIGITAL

CHARACTERISTICS / CARACTERÍSTICAS:

1

- Key Organizer
- Combination of 3 to 8 digits
- Emergency key (Includes 2 bank type keys)
- Weight: 8 kg (18 Lb)
- Material: Steel
- Organizador de llaves
- Combinación de 3 a 8 dígitos
- Llave de emergencia (Incluye 2 llaves tipo bancarias)
- Peso: 8 kg (18 Lb)
- Material: Acero

CODE/CÓDIGO	FINISH/ACABADO
SFK48EB	● Grey/Gris

SOLD SEPARATELY 200 pieces
 • Box Key Tags with metal ring different colors
 • Material: Plastic with metal ring

SE VENDEN POR SEPARADO 200 piezas
 • Caja Llaveros Porta Etiquetas Diferentes Colores
 • Material: Plástico con anillo de metal

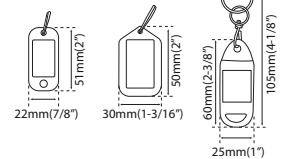
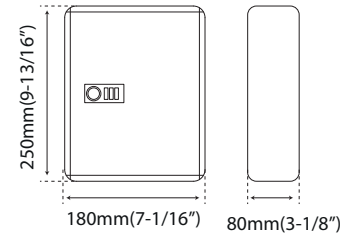

KEY CABINET

PORTALLAVES

CHARACTERISTICS / CARACTERÍSTICAS:

1/12

- Includes 2 keys
- Material: Steel
- Incluye 2 llaves
- Material: Acero

CODE/CÓDIGO	FINISH/ACABADO	CAPACITY OF KEYS/CAPACIDAD DE LLAVES	CAPACITY OF KEYS		
			A	B	C
KC20	● Beige	20	200mm(7-7/8")	160mm(6-5/16")	80mm(3-1/8")
KC48	● Beige	48	300mm(11-13/16")	240mm(9-7/16")	80mm(3-1/8")
KC96	● Beige	96	300mm(11-13/16")	240mm(9-7/16")	80mm(3-1/8")

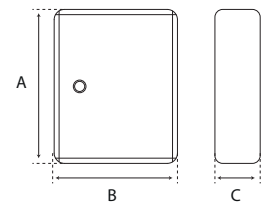

SOLD SEPARATELY 200 pieces
 • Box Key Tags with metal ring different colors
 • Material: Plastic with metal ring

SE VENDEN POR SEPARADO 200 piezas
 • Caja Llaveros Porta Etiquetas Diferentes Colores
 • Material: Plástico con anillo de metal

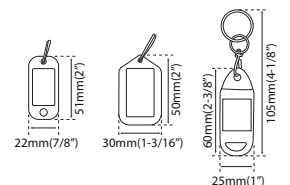

MAIL SLOTS BOCA CARTAS



EXTERIOR MAIL SLOT

BOCA CARTA EXTERIOR

CHARACTERISTICS / CARACTERÍSTICAS:

1/20

- | | |
|---|---|
| <ul style="list-style-type: none"> • Surface mount • Strong and durable • Easy Installation • Capacity: Letters only • Material: Stainless Steel 304 | <ul style="list-style-type: none"> • Montaje en superficie • Fuerte y duradero • Fácil Instalación • Capacidad: Sobre • Material: Acero Inoxidable 304 |
|---|---|

CODE/CÓDIGO FINISH/ACABADO

WLP001 ● Satin

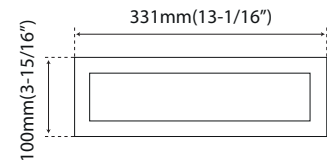

INTERIOR MAIL SLOT

BOCA CARTA INTERIOR

CHARACTERISTICS / CARACTERÍSTICAS:

1/20

- | | |
|---|---|
| <ul style="list-style-type: none"> • Surface mount • Strong and durable • Easy Installation • Capacity: Letters only • Material: Stainless Steel 304 | <ul style="list-style-type: none"> • Montaje en superficie • Fuerte y duradero • Fácil instalación • Capacidad: Sobre • Material: Acero Inoxidable 304 |
|---|---|

CODE/CÓDIGO FINISH/ACABADO

WLP002 ● Satin

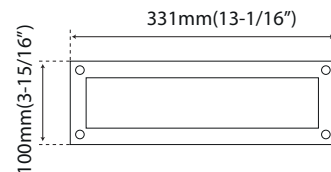

EXTERIOR MAIL SLOT

BOCA CARTA EXTERIOR

CHARACTERISTICS / CARACTERÍSTICAS:

2/20

- | | |
|--|---|
| <ul style="list-style-type: none"> • Surface mount • Strong and durable • Easy Installation • Capacity: Letters only • Weather resistant • Material: Brass | <ul style="list-style-type: none"> • Montaje en superficie • Fuerte y duradero • Fácil instalación • Capacidad: Sobre • Resistente al clima • Material: Latón |
|--|---|

CODE/CÓDIGO FINISH/ACABADO

6931NS ● Satin Nickel/Niquel Satin
6931LA ● Antique Brass/Latón Antiguo
6931LP ● Polished Brass/Latón Pulido

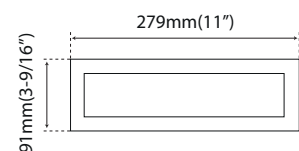



COAT HOOK

PERCHA

CHARACTERISTICS / CARACTERÍSTICAS:

25/250

- Mounting hardware included
- Material: Acero Inoxidable 304
- Material: Stainless Steel 304

CODE/CÓDIGO	FINISH/ACABADO
WHK001	● Satin
WHK001PSS	● Polished/Pulido
WHK001NSS	● Matt Black/Negro Mate
WHK001CSS	● Copper/Cobre

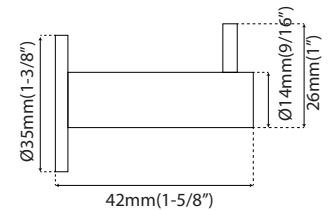

COAT HOOK

PERCHA CUADRADA

CHARACTERISTICS / CARACTERÍSTICAS:

25/250

- Mounting hardware included
- Material: Acero Inoxidable 304
- Material: Stainless Steel 304

CODE/CÓDIGO	FINISH/ACABADO
WHK002	● Satin
WHK002PSS	● Polished/Pulido

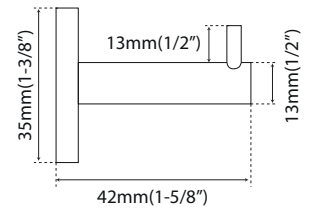

SIMPLE HOOK

PERCHA SIMPLE

CHARACTERISTICS / CARACTERÍSTICAS:

20

- Mounting hardware included

CODE/CÓDIGO	FINISH/ACABADO	MATERIAL
6732/8022NS	● Satin Nickel/Niquel Satin	Brass/Latón
6732/8022ORB	● Black/Negro	Brass/Latón
6732/8022SB	● Matte Brass/Latón Mate	Brass/Latón
CMHD101NS	● Satin Nickel/Niquel Satin	Aluminum/Aluminio
CMHD101NE	● Black/Negro	Aluminum/Aluminio

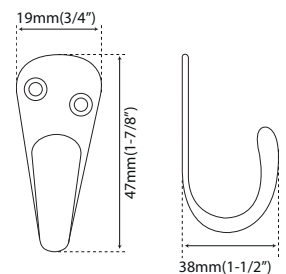

LNS
MANUFACTURING





COAT HOOK

PERCHA

CHARACTERISTICS / CARACTERÍSTICAS:

1/10

- Mounting hardware included
- For decorative and/or functional use
- Material: Zinc Alloy
- Uso: Decorativo y / o funcional
- Material: Zamak

CODE/CÓDIGO	FINISH/ACABADO
TUR.PER.2108N	● BLACK/NEGRO
TUR.PER.2108G	● GRAY/GRIS
TUR.PER.2108L	● BRASS/LATÓN
TUR.PER.2108C	● BROWN/CAFÉ

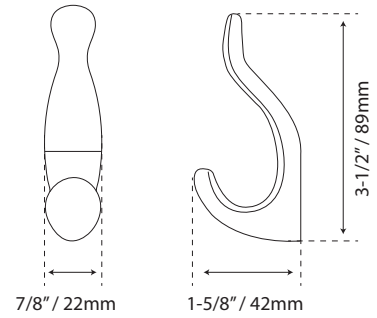

All measurements are approximate / Las medidas son aproximadas

LNS
MANUFACTURING





COAT HOOK

PERCHA

CHARACTERISTICS / CARACTERÍSTICAS:

1/10

- Mounting hardware included
- For decorative and/or functional use
- Material: Zinc Alloy
- Uso: Decorativo y / o funcional
- Material: Zamak

CODE/CÓDIGO	FINISH/ACABADO
TUR.PER.2109N	● BLACK/NEGRO
TUR.PER.2109G	● GRAY/GRIS
TUR.PER.2109L	● BRASS/LATÓN
TUR.PER.2109C	● BROWN/CAFÉ

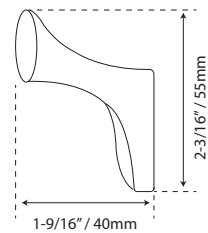
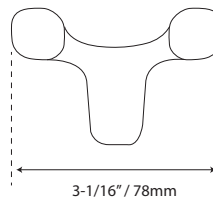





COAT HOOK

PERCHA



CHARACTERISTICS / CARACTERÍSTICAS:

1/10

- Mounting hardware included
- For decorative and/or functional use
- Material: Zinc Alloy
- Uso: Decorativo y / o funcional
- Material: Zamak

CODE/CÓDIGO	FINISH/ACABADO
TUR.PER.3016NB	● BLACK/WHITE NEGRO/BLANCO
TUR.PER.3016GM	● GREY/WOOD GRIS/MADERA
TUR.PER.3016NLM	● BLACK/MATT BRASS NEGRO/LATÓN MATE

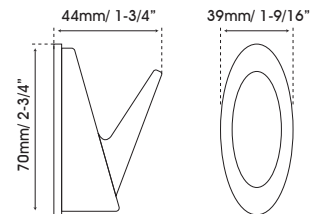

DOUBLE COAT HOOK

PERCHA DOBLE



CHARACTERISTICS / CARACTERÍSTICAS:

20

- Mounting hardware included

CODE/CÓDIGO	FINISH/ACABADO	MATERIAL
6745/8017NS	● Satin Nickel/Niquel Satin	Brass/Latón
6745/8017ORB	● Black/Negro	Brass/Latón
6745/8017LA	● Antique Brass/Latón Antiguo	Brass/Latón
6745/8017LP	● Polished Brass/Latón Pulido	Brass/Latón
CMHD102NS	● Satin Nickel/Niquel Satin	Aluminum/Aluminio
CMHD102NE	● Black/Negro	Aluminum/Aluminio

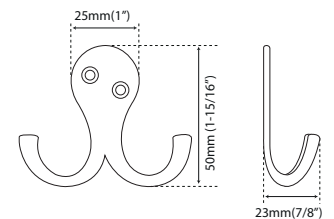

DOUBLE COAT HOOK

PERCHA DOBLE



CHARACTERISTICS / CARACTERÍSTICAS:

20

- Mounting hardware included
- Material: Zinc Alloy
- Material: Zamak

CODE/CÓDIGO	FINISH/ACABADO
CMHD104	● Satin Nickel/Niquel Satin

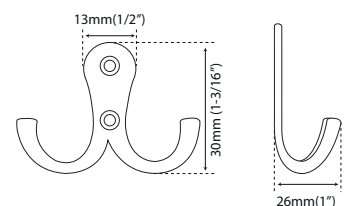



COAT HOOK W/ DOOR STOP

TOPE DE PARED Y PERCHERO

CHARACTERISTICS / CARACTERÍSTICAS: 10/80

- Mounting hardware included
- Material: Stainless Steel 304
- Material: Acero Inoxidable 304

CODE/CÓDIGO	FINISH/ACABADO
CMD018	● Satin

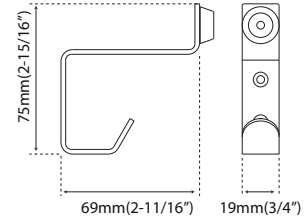

COAT HOOK

PERCHA SIMPLE

CHARACTERISTICS / CARACTERÍSTICAS: 20

- Mounting hardware included
- For decorative and/or functional use
- Material: Brass
- Uso: Decorativo y / o funcional
- Material: Latón

CODE/CÓDIGO	FINISH/ACABADO
6736/8043NS	● Satin Nickel/Niquel Satin
6736/8043LP	● Polished Brass/Latón Pulido

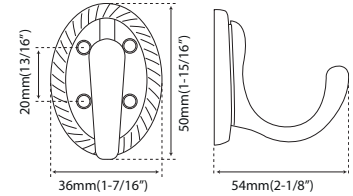

HORSE COAT HOOK

PERCHA CABALLO

CHARACTERISTICS / CARACTERÍSTICAS: 10

- Mounting hardware included
- For decorative and/or functional use
- Material: Brass
- Uso: Decorativo y / o funcional
- Material: Latón

CODE/CÓDIGO	FINISH/ACABADO	A	B	C	D	E
6728NS	● Satin Nickel/Niquel Satin	18mm (11/16")	25mm (1")	125mm (4-15/16")	62mm (2-7/16")	54mm (2-1/8")
6702NS	● Satin Nickel/Niquel Satin	24mm (15/16")	30mm (1-3/16")	150mm (5-7/8")	68mm (2-11/16")	57mm (2-1/4")

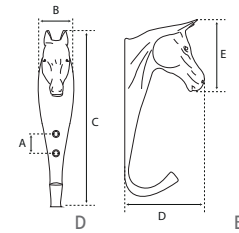

DOLPHIN COAT HOOK

PERCHA DELFIN

CHARACTERISTICS / CARACTERÍSTICAS: 5

- Mounting hardware included
- For decorative and/or functional use
- Material: Brass
- Uso: Decorativo y / o funcional
- Material: Latón

CODE/CÓDIGO	FINISH/ACABADO
6730NS	● Satin Nickel/Niquel Satin
6730LP	● Polished Brass/Latón Pulido

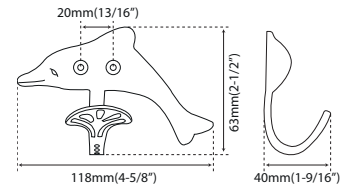

ANCHOR COAT HOOK

PERCHA ANCLA

CHARACTERISTICS / CARACTERÍSTICAS: 5

- Mounting hardware included
- For decorative and/or functional use
- Material: Brass
- Uso: Decorativo y / o funcional
- Material: Latón

CODE/CÓDIGO	FINISH/ACABADO
6731NS	● Satin Nickel/Niquel Satin
6731LP	● Polished Brass/Latón Pulido

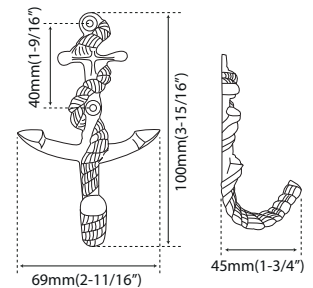

BEAR COAT HOOK

PERCHA OSO

CHARACTERISTICS / CARACTERÍSTICAS: 10

- Mounting hardware included
- For decorative and/or functional use
- Material: Brass
- Uso: Decorativo y / o funcional
- Material: Latón

CODE/CÓDIGO	FINISH/ACABADO
6729NS	● Satin Nickel/Niquel Satin

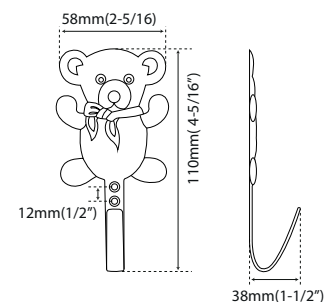

COAT HOOK RACK

PERCHERO



CHARACTERISTICS / CARACTERÍSTICAS:

10

- Mounting hardware included
- Material: Stainless Steel 304
- Material: Acero Inoxidable 304

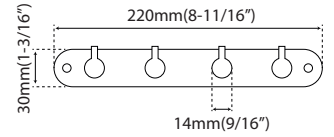

CODE/CÓDIGO FINISH/ACABADO

WHK027SS ● Satin

COAT HOOK RACK

PERCHERO



CHARACTERISTICS / CARACTERÍSTICAS:

25/250

- Mounting hardware included
- Material: Stainless Steel 304
- Material: Acero Inoxidable 304

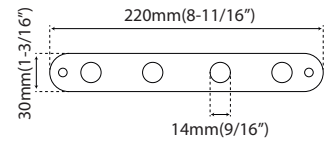

CODE/CÓDIGO FINISH/ACABADO

WHK029SS ● Satin

COAT HOOK RACK

PERCHERO



CHARACTERISTICS / CARACTERÍSTICAS:

1/10

- Mounting hardware included
- Material: Brass
- Material: Latón

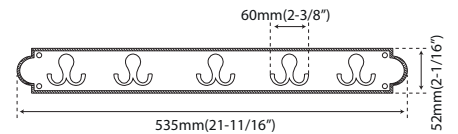

CODE/CÓDIGO FINISH/ACABADO

6748NS ● Satin Nickel/Niquel Satin

HOOK RACK

PERCHERO



CHARACTERISTICS / CARACTERÍSTICAS:

1/10

- Mounting hardware included
- Material: Brass
- Material: Latón

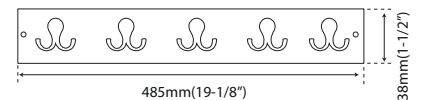

CODE/CÓDIGO FINISH/ACABADO

6749NS ● Satin Nickel/Niquel Satin
6749LP ● Polished Brass/Latón Pulido



HOOK

PERCHA

CHARACTERISTICS / CARACTERÍSTICAS:

- Mounting hardware included
- For decorative and functional use
- Material: Stainless Steel 304
- Uso: Decorativo y funcional
- Material: Acero Inoxidable 304

CODE/CÓDIGO FINISH/ACABADO
PERCHERO 5 ● Satin

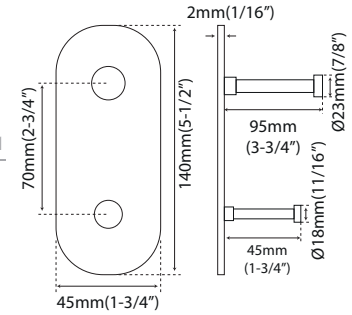

HOOK

PERCHA

CHARACTERISTICS / CARACTERÍSTICAS:

- Mounting hardware included
- For decorative and functional use
- Material: Stainless Steel 304
- Uso: Decorativo y / o funcional
- Material: Acero Inoxidable 304

CODE/CÓDIGO FINISH/ACABADO
PT-92019 ● Satin

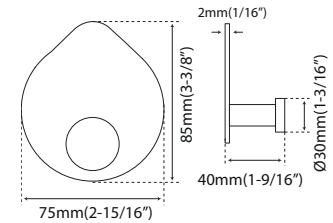

COAT HOOK

PERCHA

CHARACTERISTICS / CARACTERÍSTICAS:

- Mounting hardware included
- For decorative and/or functional use
- Material: Stainless Steel 304
- Uso: Decorativo y / o funcional
- Material: Acero Inoxidable 304

CODE/CÓDIGO FINISH/ACABADO
PT-92017 ● Satin

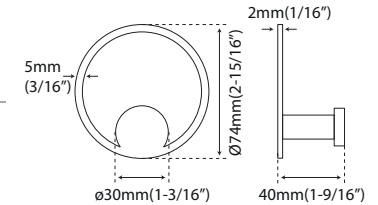

OVER-THE-DOOR HOOK

COLGADOR DE SOBREPONER

CHARACTERISTICS / CARACTERÍSTICAS:

- To place on the door
- Hangs over top of door
- For decorative and/or functional use
- Material: Stainless Steel 304
- Para colocar sobre la puerta
- Uso: Decorativo y / o funcional
- Material: Acero Inoxidable 304

CODE/CÓDIGO FINISH/ACABADO
JK1450935 ● Satin

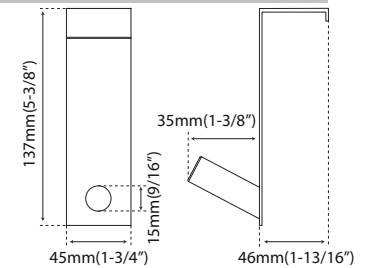

DOUBLE COAT HOOK

PERCHERO DOBLE

CHARACTERISTICS / CARACTERÍSTICAS:

- Mounting hardware included
- For decorative and/or functional use
- Material: Stainless Steel 304
- Uso: Decorativo y / o funcional
- Material: Acero Inoxidable 304

CODE/CÓDIGO FINISH/ACABADO
BA38303 ● Satin

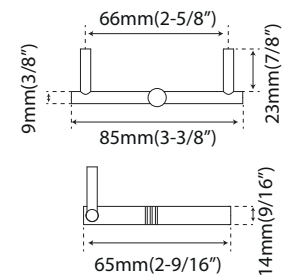

WALL MOUNTED HIDDEN COAT & HAT HOOK

PERCHA OCULTA DE PARED

CHARACTERISTICS / CARACTERÍSTICAS:

- Recommended for use inside the closet to hang personal belongings like hats or coats
- This hanger goes hidden into wall or due to its design can be use in both sides of a furniture wall
- Material: Brass
- Puede ir un solo lado oculto dentro de la pared o puede instalarse en un mueble para que salga de ambos lados
- Ideal dentro de closets
- Material: Latón

CODE/CÓDIGO FINISH/ACABADO MATERIAL
6X9.5MMNS ● Satin Nickel /Niquel Satin Brass/Latón
6X9.5MMLP ● Polished Brass/Latón Pulido Brass/Latón
CJO01SS ● Satin Stainless Steel / Acero Inoxidable

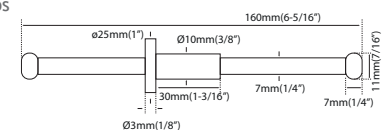

All measurements are approximate / Las medidas son aproximadas



DOOR BELL

INTERRUPTOR PARA TIMBRE

CHARACTERISTICS / CARACTERÍSTICAS:

10

• Material: Stainless Steel 304

• Material: Acero Inoxidable 304

CODE/CÓDIGO FINISH/ACABADO

JK24201

● Satin

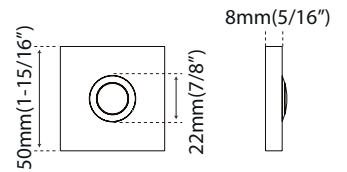

DOOR BELL

INTERRUPTOR PARA TIMBRE

CHARACTERISTICS / CARACTERÍSTICAS:

10

• Material: Stainless Steel 304

• Material: Acero Inoxidable 304

CODE/CÓDIGO FINISH/ACABADO

JK24202

● Satin

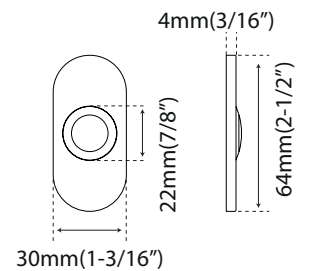

DOOR BELL

INTERRUPTOR PARA TIMBRE

CHARACTERISTICS / CARACTERÍSTICAS:

10

• Material: Stainless Steel 304

• Material: Acero Inoxidable 304

CODE/CÓDIGO FINISH/ACABADO

JK24203

● Satin

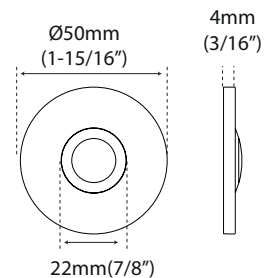

RETRACTABLE CLOTHES LINE

COLGADOR EXTENSIBLE PARA BAÑO

CHARACTERISTICS / CARACTERÍSTICAS:

1/50

- Cord Length: 9"
- Ideal for bathrooms
- Material: Stainless Steel 304

- Cordón de 2.76 mts
- Ideal para baños
- Material: Acero Inoxidable 304

CODE/CÓDIGO FINISH/ACABADO

JC475930P11

● Polished/Pulido

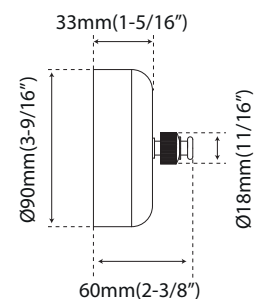



PULL PLATE MOD. 108

PLACA DE EMPUJE

CHARACTERISTICS / CARACTERÍSTICAS:



- Strong and durable
- Ideal for high traffic
- Commercial use
- Material: Stainless Steel 304
- Fuerte y duradero
- Ideal para puertas con mucho tráfico
- Material: Acero Inoxidable 304

CODE/CÓDIGO	FINISH/ACABADO	A	B	A	B
PJ108300SS	● Satin	300 x 75mm	11-13/16 x 2-15/16"		
PJ108400NE	● Black/Negro	400 x 100mm	15-3/4 x 3-15/16"		
PJ108400SS	● Satin	400 x 100mm	15-3/4 x 3-15/16"		

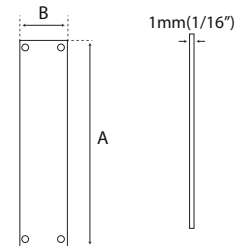

PULL PLATE MOD. 108

PLACA DE EMPUJE

CHARACTERISTICS / CARACTERÍSTICAS:



- Strong and durable
- Ideal for high traffic
- Commercial use
- Material: Stainless Steel 304
- Fuerte y duradero
- Ideal para puertas con mucho tráfico
- Material: Acero Inoxidable 304

CODE/CÓDIGO	FINISH/ACABADO	A	B	A	B
PJ108170SS	● Satin	170 x 170mm	6-11/16 x 6-11/16"		

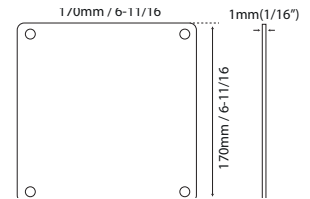

PULL PLATE MOD. 107

PLACA DE EMPUJE

CHARACTERISTICS / CARACTERÍSTICAS:



- Strong and durable
- Ideal for high traffic
- Commercial use
- Material: Stainless Steel 304
- Fuerte y duradero
- Ideal para puertas con mucho tráfico
- Material: Acero Inoxidable 304

CODE/CÓDIGO	FINISH/ACABADO	A	B	A	B
PJ107300SS	● Satin	300x75mm	11-13/16 x 2-15/16"		
PJ107400NE	● Black/Negro	400x100mm	15-3/4 x 3-15/16"		
PJ107400SS	● Satin	400x100mm	15-3/4 x 3-15/16"		

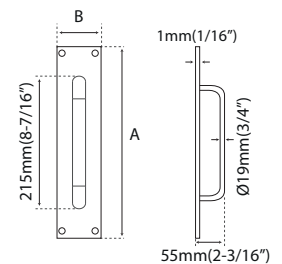

KICK PLATES

PLACAS DE PROTECCIÓN PARA PUERTAS

PT-000845

CODE/CÓDIGO	W	H	T
PT-000845-34X4	34" / 853mm	4" / 101mm	0.05" / 1.27mm
PT-000845-34X8	34" / 853mm	8" / 203mm	0.05" / 1.27mm
PT-000845-34X12	34" / 853mm	12" / 305mm	0.05" / 1.27mm
PT-000845-34X16	34" / 853mm	16" / 406mm	0.05" / 1.27mm
PT-000845-36X8	36" / 915mm	8" / 203mm	0.05" / 1.27mm
PT-000845-36X12	36" / 915mm	12" / 305mm	0.05" / 1.27mm
PT-000845-36x16	36" / 915mm	16" / 406mm	0.05" / 1.27mm
PT-000845-36X20	36" / 915mm	20" / 508mm	0.05" / 1.27mm
PT-000845-38X12	38" / 965mm	12" / 305mm	0.05" / 1.27mm
PT-000845-38x14	38" / 965mm	14" / 355mm	0.05" / 1.27mm
PT-000845-38X16	38" / 965mm	16" / 406mm	0.05" / 1.27mm
PT-000845-38X18	38" / 965mm	18" / 457mm	0.05" / 1.27mm
PT-000845-38X20	38" / 965mm	20" / 508mm	0.05" / 1.27mm
PT-000845-40X12	40" / 1016mm	12" / 305mm	0.05" / 1.27mm
PT-000845-40X16	40" / 1016mm	16" / 406mm	0.05" / 1.27mm
PT-000845-40X18	40" / 1016mm	18" / 457mm	0.05" / 1.27mm
PT-000845-40X20	40" / 1016mm	20" / 508mm	0.05" / 1.27mm
PT-000845-40X22	40" / 1016mm	22" / 559mm	0.05" / 1.27mm
PT-000845-48X20	48" / 1219mm	20" / 508mm	0.05" / 1.27mm
PT-000845-48X24	48" / 1219mm	24" / 609mm	0.05" / 1.27mm
PT-000845-48X28	48" / 1219mm	28" / 711mm	0.05" / 1.27mm
PT-000845-48X32	48" / 1219mm	32" / 813mm	0.05" / 1.27mm
PT-000845-48X38	48" / 1219mm	38" / 965mm	0.05" / 1.27mm
PT-000845-48X48	48" / 1219mm	48" / 1219mm	0.05" / 1.27mm

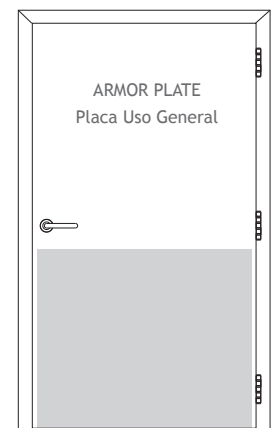
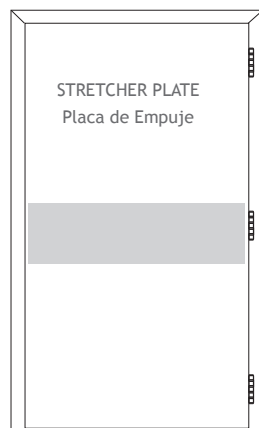
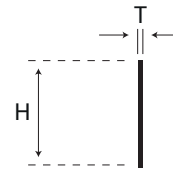
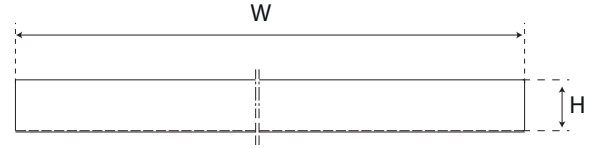

Disponible en otras medidas desde 2" - 119" Altura
24"- 48" Ancho

Material: Stainless Steel 304 or Aluminum

Finishes: Satin/Polish

Bevel: 4 edges

- May be ordered with countersunk holes at extra charge
- Screw fasteners
- Round corners - specify

Material: Acero Inoxidable 304 o Aluminio

Acabados:Satin/Pulido

Biselado: 4 aristas

- Puede pedirse con agujeros avellanados con un costo adicional
- Tornillos de fijación
- Esquinas redondeadas-especifique

All measurements are approximate / Las medidas son aproximadas

CORNER PROTECTORS

PROTECTORES DE ESQUINAS

PT-000844

CODE/CÓDIGO	H	W	T
PT-000844-25X30	1" / 25mm	30" / 762mm	0.05" / 1.27mm
PT-000844-25X34	1" / 25mm	34" / 853mm	0.05" / 1.27mm
PT-000844-25X40	1" / 25mm	40" / 1016mm	0.05" / 1.27mm
PT-000844-25X46	1" / 25mm	46" / 1168mm	0.05" / 1.27mm
PT-000844-38X30	1.5" / 38mm	30" / 762mm	0.05" / 1.27mm
PT-000844-38X34	1.5" / 38mm	34" / 853mm	0.05" / 1.27mm
PT-000844-38X40	1.5" / 38mm	40" / 1016mm	0.05" / 1.27mm
PT-000844-38X46	1.5" / 38mm	46" / 1168mm	0.05" / 1.27mm
PT-000844-50X30	2" / 50mm	30" / 762mm	0.05" / 1.27mm
PT-000844-50X34	2" / 50mm	34" / 853mm	0.05" / 1.27mm
PT-000844-50X40	2" / 50mm	40" / 1016mm	0.05" / 1.27mm
PT-000844-50X46	2" / 50mm	46" / 1168mm	0.05" / 1.27mm
PT-000844-63X30	2.5" / 63.5mm	30" / 762mm	0.05" / 1.27mm
PT-000844-63X34	2.5" / 63.5mm	34" / 853mm	0.05" / 1.27mm
PT-000844-63X40	2.5" / 63.5mm	40" / 1016mm	0.05" / 1.27mm
PT-000844-63X46	2.5" / 63.5mm	46" / 1168mm	0.05" / 1.27mm
PT-000844-76x30	3" / 76mm	30" / 762mm	0.05" / 1.27mm
PT-000844-76X34	3" / 76mm	34" / 853mm	0.05" / 1.27mm
PT-000844-76X40	3" / 76mm	40" / 1016mm	0.05" / 1.27mm
PT-000844-76X46	3" / 76mm	46" / 1168mm	0.05" / 1.27mm

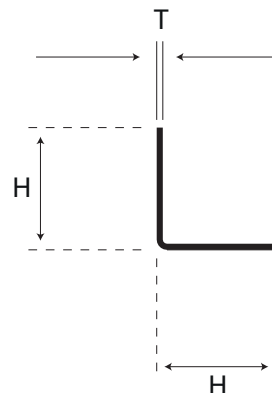
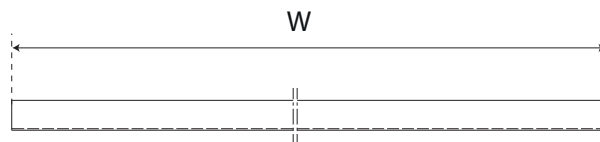

Material:
Stainless Steel 304

Optional:
With screws or without screws
Square corners or round corners

Finish:
Satin or Polish

Material:
Acero Inoxidable 304

Opcional:
Con tornillos o sin tornillos
Esquinas cuadradas o esquinas redondas

Acabados:
Satin or Pulido

VENTILATION GRILL

REJILLA

CHARACTERISTICS / CARACTERÍSTICAS:

10

• Material: Stainless Steel 304

• Material: Acero inoxidable 304

CODE/CÓDIGO	FINISH/ACABADO	GRILL/FIJACIÓN
JK23035A	● Satin	Non-perforated/ Con Adhesivo 3M
JK23035P	● Satin	Perforated/ Con tornillos

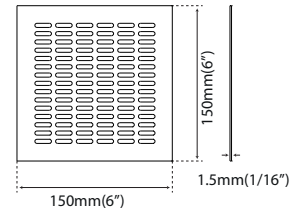

VENTILATION GRILL

REJILLA

CHARACTERISTICS / CARACTERÍSTICAS:

10

• Material: Stainless Steel 304

• Material: Acero inoxidable 304

CODE/CÓDIGO	FINISH/ACABADO	GRILL/FIJACIÓN
JK23032A	● Satin	Non-perforated/ Con Adhesivo 3M
JK23032P	● Satin	Perforated/ Con tornillos

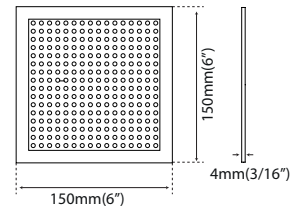

VENTILATION GRILL

REJILLA

CHARACTERISTICS / CARACTERÍSTICAS:

10

• Material: Stainless Steel 304

• Material: Acero inoxidable 304

CODE/CÓDIGO	FINISH/ACABADO	A
JK23028	● Satin	100mm (4 inches)
JK23029	● Satin	150mm (6 inches)

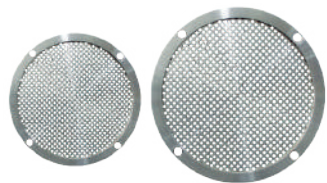
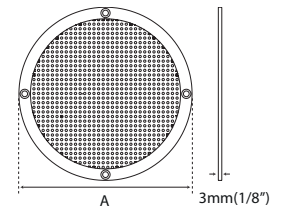

VENTILATION GRILL

REJILLA

CHARACTERISTICS / CARACTERÍSTICAS:

10

• Material: Stainless Steel 304

• Material: Acero inoxidable 304

CODE/CÓDIGO	FINISH/ACABADO	GRILL	FIJACIÓN
JK23030A	● Satin	Non-perforated	Con Adhesivo 3M
JK23030P	● Satin	Perforated	Con tornillos

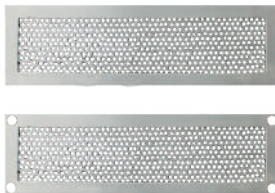
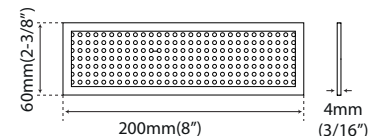

VENTILATION GRILL

REJILLA

CHARACTERISTICS / CARACTERÍSTICAS:

10

• Material: Stainless Steel 304

• Material: Acero inoxidable 304

CODE/CÓDIGO	FINISH/ACABADO	GRILL	FIJACIÓN
JK23031A	● Satin	Non-perforated	Con Adhesivo 3M
JK23031P	● Satin	Perforated	Con tornillos

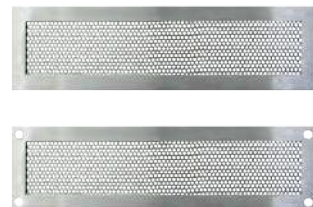
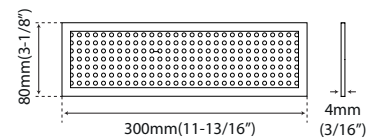

VENTILATION GRILL

REJILLA

CHARACTERISTICS / CARACTERÍSTICAS:

10

• Material: Stainless Steel 304

• Material: Acero inoxidable 304

CODE/CÓDIGO	FINISH/ACABADO	GRILL	FIJACIÓN
JK23033A	● Satin	Non-perforated	Con Adhesivo 3M
JK23033P	● Satin	Perforated	Con tornillos

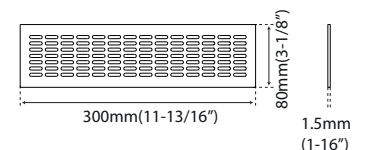

VENTILATION GRILL

REJILLA

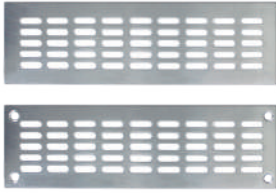

CHARACTERISTICS / CARACTERÍSTICAS:

- Material: Stainless Steel 304
- Material: Acero inoxidable 304

CODE/CÓDIGO	FINISH/ACABADO	GRILL/FIJACIÓN
JK23034A	● Satin	With adhesive 3M/Con Adhesivo 3M
JK23034P	● Satin	Perforated/Con tornillos

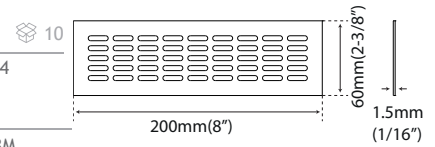

ALUMINUM GRILL

REJILLA



CHARACTERISTICS/CARACTERÍSTICAS:

- Material: Aluminum
- Material: Aluminio

CODE/CÓDIGO	FINISH/ACABADO	GRILL/FIJACIÓN
20216	● Aluminum	With mosquito net Con mosquitero
20221	○ White	With mosquito net Con mosquitero
20186	○ White	Without mosquito net Sin mosquitero

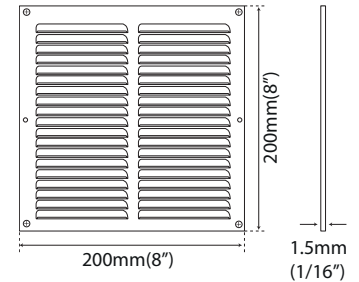

ALUMINUM GRILL

REJILLA



CHARACTERISTICS/CARACTERÍSTICAS:

- Material: Aluminum
- Material: Aluminio

CODE/CÓDIGO	FINISH/ACABADO	A	B	GRILL/FIJACIÓN
20187	● Aluminum/Aluminio	100mmx200mm (4"x8")		With mosquito net Con mosquitero
20189	● Aluminum/Aluminio	150mmx300mm (6"x11-13/16")		Without mosquito net Sin mosquitero
20192	○ White/Blanco	100mmx200mm (4"x8")		Without mosquito net Sin mosquitero
20194	○ White/Blanco	150mmx300mm (6"x11-13/16")		Without mosquito net Sin mosquitero
20212	● Aluminum/Aluminio	100mmx200mm (4"x8")		With mosquito net Con mosquitero
20217	○ White/Blanco	100mmx200mm (4"x8")		With mosquito net Con mosquitero
20219	○ White/Blanco	150mmx300mm (6"x11-13/16")		With mosquito net Con mosquitero

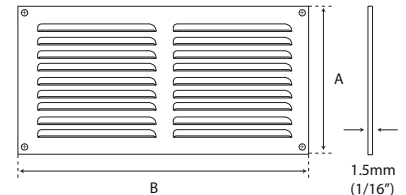

ALUMINUM GRILL

REJILLA



CHARACTERISTICS / CARACTERÍSTICAS:

- Material: Aluminum
- Material: Aluminio

CODE/CÓDIGO	FINISH/ACABADO	GRILL/FIJACIÓN	A	B	GRILL/FIJACIÓN
20183	● Aluminum/Aluminio	With screws/Con tornillos	150mmx150mm (6"x6")		With mosquito net Con mosquitero
20188	● Aluminum/Aluminio	With screws/Con tornillos	150mmx150mm (6"x6")		Without mosquito net Sin mosquitero
20190	● Aluminum/Aluminio	With screws/Con tornillos	170mmx170mm (6-11/16"x 6-11/16")		Without mosquito net Sin mosquitero
20213	● Aluminum/Aluminio	With screws/Con tornillos	150mmx150mm (6"x6")		With mosquito net Con mosquitero
20220	○ White/Blanco	With screws/Con tornillos	170mmx170mm (6-11/16"x 6-11/16")		With mosquito net Con mosquitero
3226	○ White/Blanco	With screws/Con tornillos	170mmx170mm (6-11/16"x 6-11/16")		With mosquito net Con mosquitero
3227	● Aluminum/Aluminio	With Clip/Con Clip	165mmx165mm (6-1/2"x6-1/2")		With mosquito net Con mosquitero

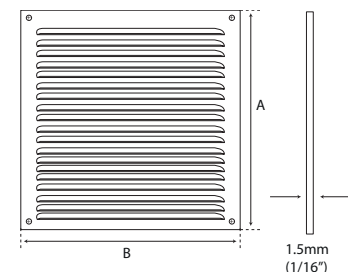



HANDRAIL BRACKETS

SOPORTE PASAMANOS

CHARACTERISTICS / CARACTERÍSTICAS:

10/50

- Wall-mounted bracket
- For 2" handrail Adjustable
- Material: Stainless Steel 316
- Soporte montado al muro
- Para tubo 50mm ajustable
- Material: Acero Inoxidable 316

CODE/CÓDIGO	FINISH/ACABADO
JPW002SSS	● Satin
JPW002PSS	● Polished/Brillo

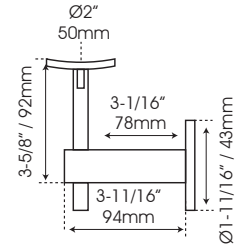

HANDRAIL BRACKETS

SOPORTE PASAMANOS

CHARACTERISTICS / CARACTERÍSTICAS:

10/50

- Wall-mounted bracket
- Swivel
- Adjustable
- Material: Stainless Steel 316
- Soporte montado al muro
- Giratorio
- Ajustable
- Material: Acero Inoxidable 316

CODE/CÓDIGO	FINISH/ACABADO
PT-3038-1	● Satin

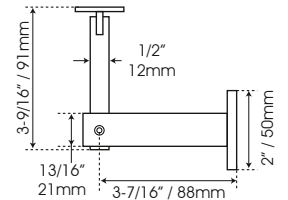

HANDRAIL BRACKETS

SOPORTE PASAMANOS

CHARACTERISTICS / CARACTERÍSTICAS:

10/50

- Wall-mounted bracket
- For 1-1/2" handrail
- Highly resistant to corrosion
- Ideal for aggressive saline environments
- Material: Stainless Steel 316
- Soporte montado al muro
- Para tubo 38mm
- Altamente resistente a la corrosión
- Ideal para ambientes salinos más agresivos
- Material: Acero Inoxidable 316

CODE/CÓDIGO	FINISH/ACABADO
JPW020SSS	● Satin

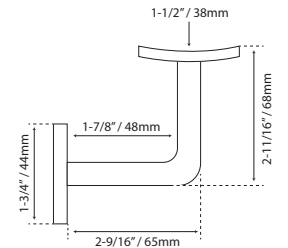

HANDRAIL BRACKETS

SOPORTE PASAMANOS

CHARACTERISTICS / CARACTERÍSTICAS:

10/50

- Wall-mounted bracket
- For 1-1/2" handrail
- Material: Stainless Steel 304
- Soporte montado al muro
- Para tubo 38mm
- Material: Acero Inoxidable 304

CODE/CÓDIGO	FINISH/ACABADO
JPW021SSS	● Satin

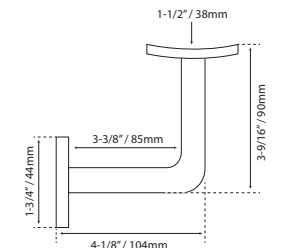

HANDRAIL BRACKETS

SOPORTE PASAMANOS

CHARACTERISTICS / CARACTERÍSTICAS:

10/50

- Wall-mounted bracket
- Fixed
- For 2" handrail
- Material: Stainless Steel 304
- Soporte montado al muro (Fijo)
- Para tubo 20.8mm
- Material: Acero Inoxidable 304

CODE/CÓDIGO	FINISH/ACABADO
JP011SS	● Satin

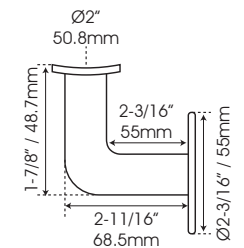

HANDRAIL BRACKETS

SOPORTE PASAMANOS

CHARACTERISTICS / CARACTERÍSTICAS:

10/50

- Wall-mounted bracket
- Fixed
- Material: Stainless Steel 304
- Soporte montado al muro (Fijo)
- Material: Acero Inoxidable 304

CODE/CÓDIGO	FINISH/ACABADO
JP031SS	● Satin

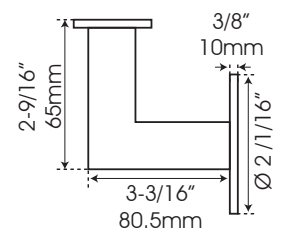

HANDRAIL BRACKETS

SOPORTE DE PIE



CHARACTERISTICS / CARACTERÍSTICAS:

- Wall-mounted bracket
- Fixed
- For 2" handrail or foot rail
- Material: Stainless Steel 304
- Soporte montado al muro
- Fijo
- Para tubo 50.8 mm
- Material: Acero Inoxidable 304

CODE/CÓDIGO FINISH/ACABADO
CY-06 ● Satin

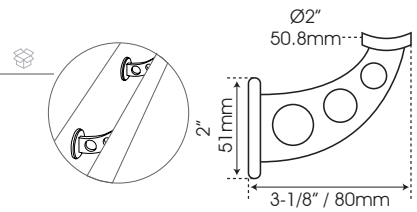

HANDRAIL BRACKETS

SOPORTE DE PIE



CHARACTERISTICS / CARACTERÍSTICAS:

- Floor/Wall-mounted brackets
- Fixed
- For 2" foot rail
- Material: Stainless Steel 304
- Soporte montado al muro / piso
- Fijo
- Para tubo 50.8mm
- Material: Acero Inoxidable 304

CODE/CÓDIGO FINISH/ACABADO
CY-50 ● Satin

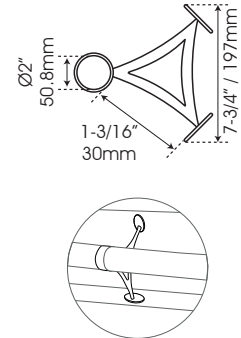

WALL-MOUNTED BRACKET

SOPORTE MONTADO AL MURO



CHARACTERISTICS / CARACTERÍSTICAS:

- Wall-mounted bracket
- Round base (swivel)
- For 2" foot rail
- Material: Stainless Steel 304
- Soporte montado al muro
- Base redonda (giratorio)
- Para tubo 50.8mm
- Material: Acero Inoxidable 304

CODE/CÓDIGO FINISH/ACABADO
CY-50 ● Satin

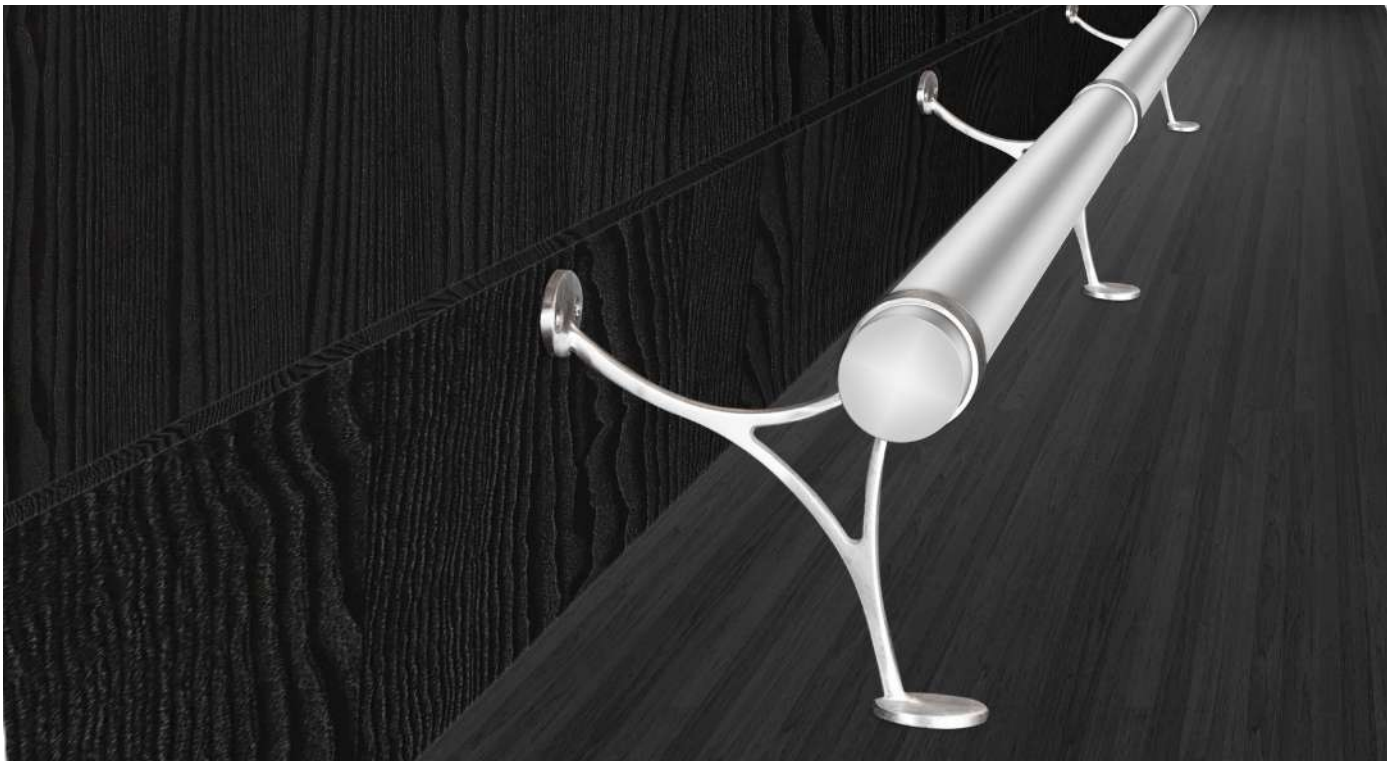
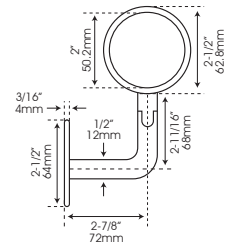



WOMEN/MEN RESTROOM SIGN

SEÑALETICA GRANDE MUJER/HOMBRE

CHARACTERISTICS / CARACTERÍSTICAS:

- Surface mount
- Material: Stainless Steel 304
- Fijación con tornillos
- Material: Acero Inoxidable 304

CODE/CÓDIGO	FINISH/ACABADO	DESCRIPTION	DESCRIPCIÓN
PT-000652	● Satin	Women	Mujer
PT-000579	● Satin	Men	Hombre

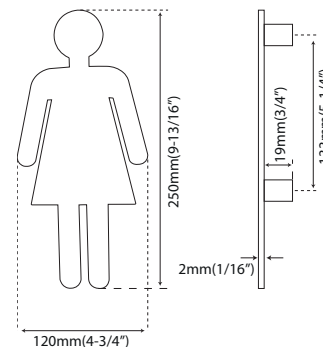

WOMEN/MEN RESTROOM SIGN

SEÑALETICA MUJER / HOMBRE

CHARACTERISTICS / CARACTERÍSTICAS:

- Fixation with 3M Adhesive
- Material: Stainless Steel 304
- Fijación con Adhesivo 3M
- Material: Acero Inoxidable 304

CODE/CÓDIGO	FINISH/ACABADO	DESCRIPTION	DESCRIPCIÓN	A	B
PT-000908	● Satin	Women	Mujer	72mm(2-13/16")	34mm(1-5/16")
PT-000909	● Satin	Men	Hombre	72mm(2-13/16")	28mm(1-1/8")
PT-000771	● Satin	Women	Mujer	110mm(4-5/16")	42mm(1-5/8")
PT-000772	● Satin	Men	Hombre	110mm(4-5/16")	42mm(1-5/8")

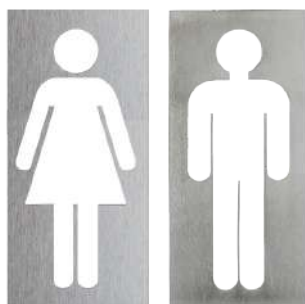
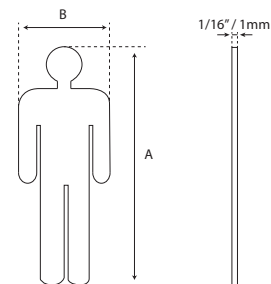

MEN/WOMEN RESTROOM SIGN

SEÑALETICA BIG

CHARACTERISTICS / CARACTERÍSTICAS:

- Fixation with 3M Adhesive
- Material: Stainless Steel 304
- Fijación con Adhesivo 3M
- Material: Acero Inoxidable 304

CODE/CÓDIGO	FINISH/ACABADO	DESCRIPTION
PT-000706	● Satin	Women
PT-000600	● Satin	Men

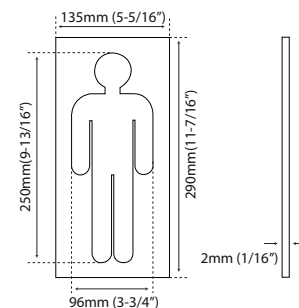

WOMEN/MEN RESTROOM SIGN
SEÑALETICA



SYM-VARIOUS SIGNS

SEÑALETICA

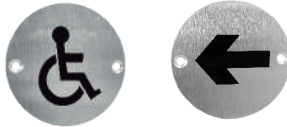

CHARACTERISTICS / CARACTERÍSTICAS:

- Surface mount
- FINISH/ACABADO: ● Satin
- Material: Stainless Steel 304
- Fijación con tornillos
- Acabado: ● Satin
- Material: Acero Inoxidable 304

CODE/CÓDIGO	DESCRIPTION	DESCRIPCIÓN
● 6752	"Men-Woman"	"Hombre-Mujer"
● 6754	"No Smoking"	"No Fumar"
● 6755	"No Pets"	"No Mascotas"
● SP010	"Baby Changer"	"Cambiador de bebé"
● SYMM10	"Women"	"Mujer"
● SYMH10	"Men"	"Hombre"
● SYMMIN10	"Handicap"	"Minusvalido"
● SYMCAF10	"Coffee"	"Café"
● SYMFU10	"No Smoking"	"No Fumar"
● SYMPE10	"No Pets"	"No Perros"
● SYMIN10	"Information"	"Información"
● SYMFLE10	"Arrow"	"Flecha"
● SYMTEL10	"Telephone"	"Teléfono"

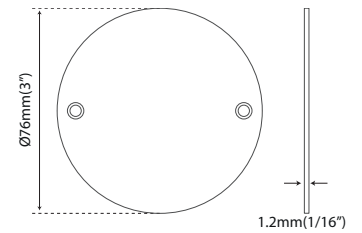

RESTROOM SIGNS

SEÑALETICA CIK

CHARACTERISTICS / CARACTERÍSTICAS:

- Fixation with 3M Adhesive
- Finish: ● Satin
- Matt Black
- Material: Stainless Steel 304
- Fijación con Adhesivo 3M
- Finish: ● Satin
- Negro Mate
- Material: Acero Inoxidable 304

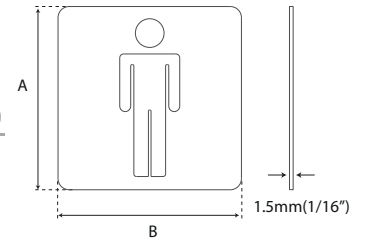

SATIN	Matt Black/NEGRO MATE	DESCRIPTION	DESCRIPCIÓN	A	B
● PT-000550	● PT-000550MB	Extinguisher	Extintor	150mmx150mm(5-7/8")	
● PT-000551	● PT-000551MB	Men	Hombre	150mmx150mm(5-7/8")	
● PT-000552	● PT-000552MB	Women	Mujer	150mmx150mm(5-7/8")	
● PT-000553	● PT-000553MB	Men-Woman	Hombre-Mujer	150mmx150mm(5-7/8")	



VARIOUS SIGNS

SEÑALETICA

CHARACTERISTICS / CARACTERÍSTICAS:

- Fixation with 3M Adhesive
- FINISH/ACABADO: ● Satin
- Material: Stainless Steel 304
- Fijación con Adhesivo 3M
- Acabado: ● Satin
- Material: Acero Inoxidable 304

CODE/CÓDIGO	DESCRIPTION	DESCRIPCIÓN
● PT-000554	Extinguisher	Extintor
● PT-000710	Horizontal arrow	Flecha

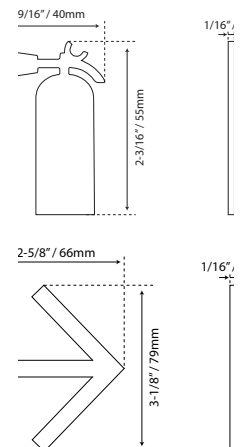



VARIOUS SIGN PLAQUES

SEÑALETICA

CHARACTERISTICS / CARACTERÍSTICAS:



- Fixation with 3M Adhesive
- Finish: ● Satin
- Matt Black
- Material: Stainless Steel 304
- Fijación con Adhesivo 3M
- Acabado: ● Satin
- Negro Mate
- Material: Acero Inoxidable 304

SATIN	Matt Black/ NEGRO MATE	DESCRIPTION	DESCRIPCIÓN
● PT-95201	● PT-95201MB	“Men”	“Hombre”
● PT-95202	● PT-95202MB	“Women”	“Mujer”
● PT-95203	● PT-95203MB	“Handicap”	“Discapacitado”
● PT-95204	● PT-95204MB	“Office”	“Oficina”
● PT-95205	● PT-95205MB	“Meeting”	“Sala de Reunión”
● PT-95206	● PT-95206MB	“Diagonal arrow”	“Flecha Diagonal”
● PT-95207	● PT-95207MB	“Horizontal arrow”	“Flecha Horizontal”
● PT-95208	● PT-95208MB	“Elevator”	“Ascensor”
● PT-95209	● PT-95209MB	“Stop”	“Stop”
● PT-95210	● PT-95210MB	“@”	“@”
● PT-95211	● PT-95211MB	“Cafeteria”	“Cafetería”
● PT-95212	● PT-95212MB	“Telephone”	“Teléfono”
● PT-95213	● PT-95213MB	“No Smoking”	“No Fumar”
● PT-95214	● PT-95214MB	“Smoking permitted”	“Fumar”
● 1104.031	● 1104.031MB	“Diner”	“Comedor”
● 1105.031	● 1105.031MB	“Handicap”	“Discapacitado”
● 1109.031	● 1109.031MB	“Internet”	“Internet”
● PT-000866	● PT-000866MB	“No Parking”	“No estacionarse”

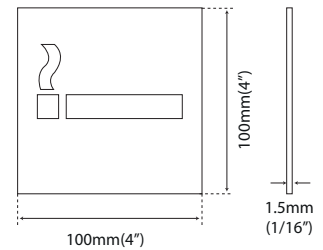

2" HOUSE LETTERS & NUMBERS

NÚMEROS Y LETRAS PEQUEÑAS

CHARACTERISTICS / CARACTERÍSTICAS:



- Fixation with screws
- Material: Stainless Steel 304
- Fijación con tornillos
- Material: Acero Inoxidable 304

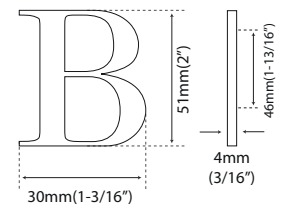

5

A

LETTER CODE/CÓDIGO	FINISH/ACABADO	NUMBER	LETTER CODE/CÓDIGO	FINISH/ACABADO	NUMBER
CL01INOX	● Satin	1	CL01P	● Polished/Pulido	1
CL02INOX	● Satin	2	CL02P	● Polished/Pulido	2
CL03INOX	● Satin	3	CL03P	● Polished/Pulido	3
CL04INOX	● Satin	4	CL04P	● Polished/Pulido	4
CL05INOX	● Satin	5	CL05P	● Polished/Pulido	5
CL06INOX	● Satin	6	CL06P	● Polished/Pulido	6
CL07INOX	● Satin	7	CL07P	● Polished/Pulido	7
CL08INOX	● Satin	8	CL08P	● Polished/Pulido	8
CL09INOX	● Satin	9	CL09P	● Polished/Pulido	9
CL00INOX	● Satin	0	CL00P	● Polished/Pulido	0
CL0AINOX	● Satin	A	CL0AP	● Polished/Pulido	A
CL0BINOX	● Satin	B	CL0BP	● Polished/Pulido	B

4" HOUSE NUMBERS

NÚMEROS



CHARACTERISTICS / CARACTERÍSTICAS:

 10

- Stand-off
- Finish: ● Satin
- Material: Stainless Steel 304
- Fijación con tornillos
- Acabado: ● Satin
- Material: Acero Inoxidable 304

CODE/CÓDIGO No. CODE/CÓDIGO No.

● NUM110	1	● NUM610	6
● NUM210	2	● NUM710	7
● NUM310	3	● NUM810	8
● NUM410	4	● NUM910	9
● NUM510	5	● NUM010	0

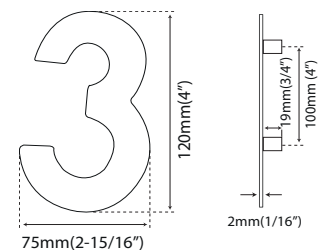

4" LETTERS

LETRAS



CHARACTERISTICS / CARACTERÍSTICAS:

 1

- Stand-off
- Finish: ● Satin
- Material: Stainless Steel 304
- Fijación con tornillos
- Acabado: ● Satin
- Material: Acero Inoxidable 304

CODE/CÓDIGO

● PT-LETA10	A
● PT-LETB10	B
● PT-LETC10	C
● PT-LETD10	D

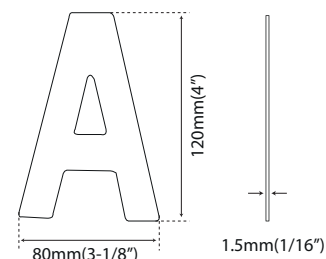

6" HOUSE NUMBERS

NÚMEROS Y LETRAS



CHARACTERISTICS / CARACTERÍSTICAS:

 10/50

- Stand-off
- Mounting hardware included
- Material: Stainless Steel 304
- Fijación con tornillos
- Material: Acero Inoxidable 304

CODE/CÓDIGO FINISH/ACABADO No. CODE/CÓDIGO FINISH/ACABADO No.

300/1P	● Polished/Pulido	1	HN001-1	● Satin	1
300/2P	● Polished/Pulido	2	HN001-2	● Satin	2
300/3P	● Polished/Pulido	3	HN001-3	● Satin	3
300/4P	● Polished/Pulido	4	HN001-4	● Satin	4
300/5P	● Polished/Pulido	5	HN001-5	● Satin	5
300/6P	● Polished/Pulido	6	HN001-6	● Satin	6
300/7P	● Polished/Pulido	7	HN001-7	● Satin	7
300/8P	● Polished/Pulido	8	HN001-8	● Satin	8
300/9P	● Polished/Pulido	9	HN001-9	● Satin	9
300/0P	● Polished/Pulido	0	HN001-0	● Satin	0
			LER0010BA	● Satin	a
			LER0010BB	● Satin	b

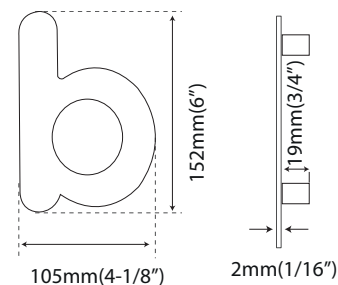

8" AND 12" BIG NUMBERS

NÚMEROS GRANDES



CHARACTERISTICS / CARACTERÍSTICAS:

 10/50

- Stand-off
- Finish: ● Satin
● Matt Black
- Material: Stainless Steel 304
- Fijación con tornillos
- Acabado: ● Satin
● Negro Mate
- Material: Acero Inoxidable 304

(A) 300mm (12")

SATIN	BLACK/NEGRO	No.
● PT-000682	● PT-000682MB	0
● PT-000535	● PT-000535MB	1
● PT-000536	● PT-000536MB	2
● PT-000537	● PT-000537MB	3
● PT-000655	● PT-000655MB	4
● PT-000658	● PT-000658MB	5
● PT-000659	● PT-000659MB	6
● PT-000660	● PT-000660MB	7
● PT-000656	● PT-000656MB	8
● PT-000657	● PT-000657MB	9

(A) 200mm (8")

SATIN	BLACK/NEGRO	No.
● PT-000525	● PT-000525MB	0
● PT-000526	● PT-000526MB	1
● PT-000527	● PT-000527MB	2
● PT-000528	● PT-000528MB	3
● PT-000529	● PT-000529MB	4
● PT-000530	● PT-000530MB	5
● PT-000531	● PT-000531MB	6
● PT-000532	● PT-000532MB	7
● PT-000533	● PT-000533MB	8
● PT-000534	● PT-000534MB	9

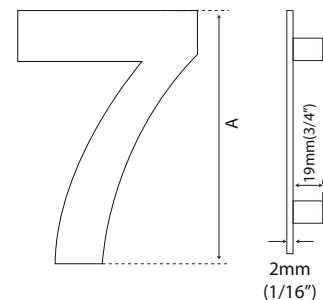

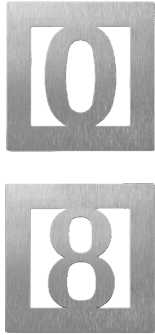

NUMBERS

NÚMEROS

CHARACTERISTICS / CARACTERÍSTICAS:

- Fixation with 3M Adhesive
- Finish: ● Satin ● Matt Black
- Material: Stainless Steel 304
- Manufacturing lead time is 2 weeks
- Fijación con Adhesivo 3M
- Acabado: ● Satin ● Negro Mate
- Material: Acero Inoxidable 304
- Bajo pedido, tiempo de fabricación 2 semanas

SATIN	Matt Black NEGRO MATE	No.	SATIN	Matt Black NEGRO MATE	No.
● PT-95000	● PT-95000MB	0	● PT-95005	● PT-95005MB	5
● PT-95001	● PT-95001MB	1	● PT-95006	● PT-95006MB	6
● PT-95002	● PT-95002MB	2	● PT-95007	● PT-95007MB	7
● PT-95003	● PT-95003MB	3	● PT-95008	● PT-95008MB	8
● PT-95004	● PT-95004MB	4	● PT-95009	● PT-95009MB	9

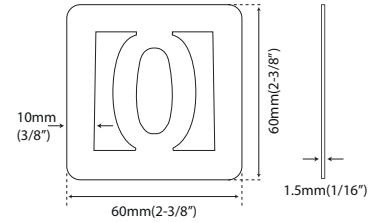

NATURE-NUMBERS

NÚMEROS

CHARACTERISTICS / CARACTERÍSTICAS:

- Stand-off
- Finish: ● Satin ● Matt Black
- Material: Stainless Steel 304
- Manufacturing lead time is 2 weeks
- Fijación con tornillos
- Acabado: ● Satin ● Negro Mate
- Material: Acero Inoxidable 304
- Bajo pedido, tiempo de fabricación 2 semanas

(A) 152mm(6")
(B) 85mm(3-3/8")

(A) 254mm(10")
(B) 152mm(6")

(A) 355mm(14")
(B) 203mm(8")

(A) 457mm(18")
(B) 254mm(10")

CODE/CÓDIGO	No.	CODE/CÓDIGO	No.	CODE/CÓDIGO	No.	CODE/CÓDIGO	No.
● PT-000361 / MB	0	● PT-000371 / MB	0	● PT-000381	0	● PT-000391	0
● PT-000362 / MB	1	● PT-000372 / MB	1	● PT-000382	1	● PT-000392	1
● PT-000363 / MB	2	● PT-000373 / MB	2	● PT-000383	2	● PT-000393	2
● PT-000364 / MB	3	● PT-000374 / MB	3	● PT-000384	3	● PT-000394	3
● PT-000365 / MB	4	● PT-000375 / MB	4	● PT-000385	4	● PT-000395	4
● PT-000366 / MB	5	● PT-000376 / MB	5	● PT-000386	5	● PT-000396	5
● PT-000367 / MB	6	● PT-000377 / MB	6	● PT-000387	6	● PT-000397	6
● PT-000368 / MB	7	● PT-000378 / MB	7	● PT-000388	7	● PT-000398	7
● PT-000369 / MB	8	● PT-000379 / MB	8	● PT-000389	8	● PT-000399	8
● PT-000370 / MB	9	● PT-000380 / MB	9	● PT-000390	9	● PT-000400	9

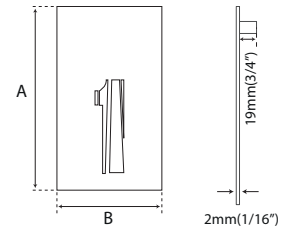

FETT-NUMBERS

NÚMEROS

CHARACTERISTICS / CARACTERÍSTICAS:

- Stand-off
- Finish: ● Satin
- Material: Stainless Steel 304
- Manufacturing lead time is 2 weeks
- Fijación con tornillos
- Acabado: ● Satin
- Material: Acero Inoxidable 304
- Bajo pedido, tiempo de fabricación 2 semanas

(A) 101mm(4") (B) 101mm(4") (A) 152mm(6") (B) 152mm(6") (A) 203mm(8") (B) 203mm(8") (A) 254mm(10") (B) 254mm(10")

CODE/CÓDIGO	No.	CODE/CÓDIGO	No.	CODE/CÓDIGO	No.	CODE/CÓDIGO	No.
● PT-000130	0	● PT-000131	0	● PT-000132	0	● PT-000133	0
● PT-000251	1	● PT-000260	1	● PT-000269	1	● PT-000278	1
● PT-000252	2	● PT-000261	2	● PT-000270	2	● PT-000279	2
● PT-000253	3	● PT-000262	3	● PT-000271	3	● PT-000280	3
● PT-000254	4	● PT-000263	4	● PT-000272	4	● PT-000281	4
● PT-000255	5	● PT-000264	5	● PT-000273	5	● PT-000282	5
● PT-000256	6	● PT-000265	6	● PT-000274	6	● PT-000283	6
● PT-000257	7	● PT-000266	7	● PT-000275	7	● PT-000284	7
● PT-000258	8	● PT-000267	8	● PT-000276	8	● PT-000285	8
● PT-000259	9	● PT-000268	9	● PT-000277	9	● PT-000286	9

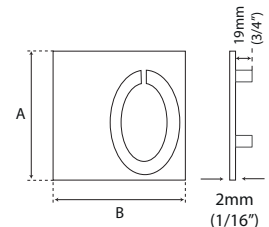

NUMBERS - SIMPLE

SEÑALETICA



ECKE-NUMBERS

NÚMEROS

CHARACTERISTICS / CARACTERÍSTICAS:



- Fixation with 3M Adhesive
- Finish: ● Satin
- Material: Stainless Steel 304
- Manufacturing lead time is 2 weeks
- Fijación con Adhesivo 3M
- Acabado: ● Satin
- Material: Acero Inoxidable 304
- Bajo pedido, tiempo de fabricación 2 semanas

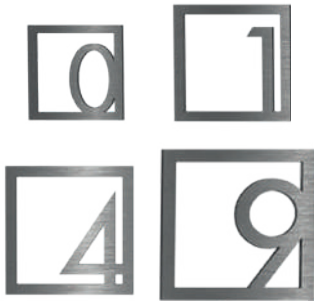
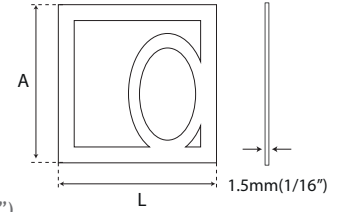

(A) 101mm(4")	(A) 152mm(6")	(A) 203mm(8")	(A) 254mm(10")
(B) 101mm(4")	(B) 152mm(6")	(B) 203mm(8")	(B) 254mm(10")

CODE/CÓDIGO	No.	CODE/CÓDIGO	No.	CODE/CÓDIGO	No.	CODE/CÓDIGO	No.
● PT-000126	0	● PT-000127	0	● PT-000128	0	● PT-000129	0
● PT-000214	1	● PT-000224	1	● PT-000233	1	● PT-000242	1
● PT-000215	2	● PT-000225	2	● PT-000234	2	● PT-000243	2
● PT-000217	3	● PT-000226	3	● PT-000235	3	● PT-000244	3
● PT-000218	4	● PT-000227	4	● PT-000236	4	● PT-000245	4
● PT-000219	5	● PT-000228	5	● PT-000237	5	● PT-000246	5
● PT-000220	6	● PT-000229	6	● PT-000238	6	● PT-000247	6
● PT-000221	7	● PT-000230	7	● PT-000239	7	● PT-000248	7
● PT-000222	8	● PT-000231	8	● PT-000240	8	● PT-000249	8
● PT-000223	9	● PT-000232	9	● PT-000241	9	● PT-000250	9

NUMBERS - STENCIL

NÚMEROS

CHARACTERISTICS / CARACTERÍSTICAS:



- Fixation with screws
- Finish: ● Satin
- Material: Stainless Steel 304
- Manufacturing lead time is 2 weeks
- Fijación con tornillos
- Acabado: ● Satin
- Material: Acero Inoxidable 304
- Bajo pedido, tiempo de fabricación 2 semanas

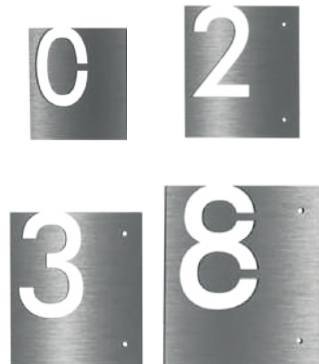
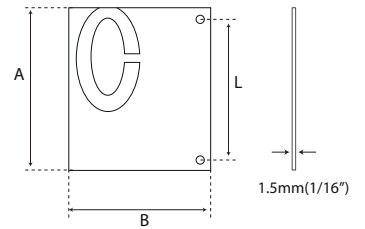

(A) 101mm(4")	(A) 152mm(6")	(A) 203mm(8")	(A) 254mm(10")
(B) 114mm(4-1/2")	(B) 130mm(5-1/4")	(B) 172mm(6-3/4")	(B) 217mm(8-1/2")
(L) 95mm(3-3/4")	(L) 117mm(4-5/8")	(L) 144mm(5-11/16")	(L) 167mm(6-9/16")

CODE/CÓDIGO	No.	CODE/CÓDIGO	No.	CODE/CÓDIGO	No.	CODE/CÓDIGO	No.
● PT-000122	0	● PT-000123	0	● PT-000124	0	● PT-000125	0
● PT-000178	1	● PT-000187	1	● PT-000196	1	● PT-000205	1
● PT-000179	2	● PT-000188	2	● PT-000197	2	● PT-000206	2
● PT-000180	3	● PT-000189	3	● PT-000198	3	● PT-000207	3
● PT-000181	4	● PT-000190	4	● PT-000199	4	● PT-000208	4
● PT-000182	5	● PT-000191	5	● PT-000200	5	● PT-000209	5
● PT-000183	6	● PT-000192	6	● PT-000201	6	● PT-000210	6
● PT-000184	7	● PT-000193	7	● PT-000202	7	● PT-000211	7
● PT-000185	8	● PT-000194	8	● PT-000203	8	● PT-000212	8
● PT-000186	9	● PT-000195	9	● PT-000204	9	● PT-000213	9

NUMBERS - SIMPLE

NÚMEROS

CHARACTERISTICS / CARACTERÍSTICAS:



- Fixation with screws
- Finish: ● Satin
- Material: Stainless Steel 304
- Manufacturing lead time is 2 weeks
- Fijación con tornillos
- Acabado: ● Satin
- Material: Acero Inoxidable 304
- Bajo pedido, tiempo de fabricación 2 semanas

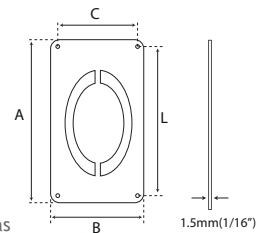

(A) 101mm(4")	(A) 152mm(6")	(A) 203mm(8")	(A) 254mm(10")
(B) 60mm(2-3/8")	(B) 88mm(3-7/16")	(B) 118mm(4-5/8")	(B) 152mm(6")
(C) 45mm(1-3/4")	(C) 68mm(2-11/16")	(C) 92mm(3-5/8")	(C) 115mm(4-1/2")
(L) 87mm(3-7/16")	(L) 129mm(5-1/162)	(L) 173mm(6-13/16")	(L) 215mm(8-7/16")

CODE/CÓDIGO	No.	CODE/CÓDIGO	No.	CODE/CÓDIGO	No.	CODE/CÓDIGO	No.
● PT-000134	0	● PT-000135	0	● PT-000136	0	● PT-000137	0
● PT-000287	1	● PT-000296	1	● PT-000305	1	● PT-000314	1
● PT-000288	2	● PT-000297	2	● PT-000306	2	● PT-000315	2
● PT-000289	3	● PT-000298	3	● PT-000307	3	● PT-000316	3
● PT-000290	4	● PT-000299	4	● PT-000308	4	● PT-000317	4
● PT-000291	5	● PT-000300	5	● PT-000309	5	● PT-000318	5
● PT-000292	6	● PT-000301	6	● PT-000310	6	● PT-000319	6
● PT-000293	7	● PT-000302	7	● PT-000311	7	● PT-000320	7
● PT-000294	8	● PT-000303	8	● PT-000312	8	● PT-000321	8
● PT-000295	9	● PT-000304	9	● PT-000313	9	● PT-000322	9