



**ALUMINUM COLLECTION
CABINET, PULLS AND KNOBS /
COLECCIÓN JALADERAS DE ALUMINIO**

HIMALAYA



COD.
KKD1073-140
KKD1073-240MB

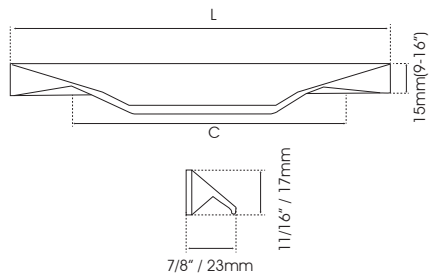

COD.
KKD1073-390

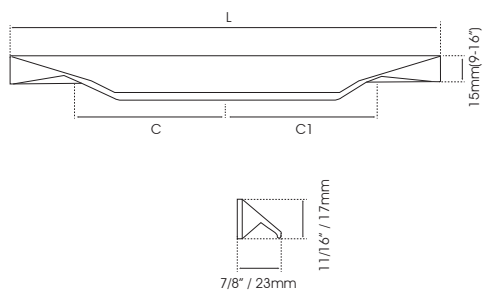

Material: Aluminum / Aluminio

CODE / CÓDIGO	FINISH / ACABADO	C	C1	L	
KKD1073-140MB	● Matt black / Negro mate	96mm (3-3/4")	-	140mm (5-1/2")	1/30
KKD1073-140LM	● Brush gold / Dorado	96mm (3-3/4")	-	140mm (5-1/2")	1/30
KKD1073-140G	● Grey / Gris	96mm (3-3/4")	-	140mm (5-1/2")	1/30
KKD1073-240MB	● Matt black / Negro mate	160mm (6-5/16")	-	240mm (9-7/16")	1/25
KKD1073-240LM	● Brush gold / Dorado	160mm (6-5/16")	-	240mm (9-7/16")	1/25
KKD1073-240G	● Grey / Gris	160mm (6-5/16")	-	240mm (9-7/16")	1/25
KKD1073-390MB	● Matt black / Negro mate	160mm (6-5/16")	160mm (6-5/16")	390mm (15-3/8")	1/25
KKD1073-390LM	● Brush gold / Dorado	160mm (6-5/16")	160mm (6-5/16")	390mm (15-3/8")	1/25
KKD1073-390G	● Grey / Gris	160mm (6-5/16")	160mm (6-5/16")	390mm (15-3/8")	1/25



BROAD

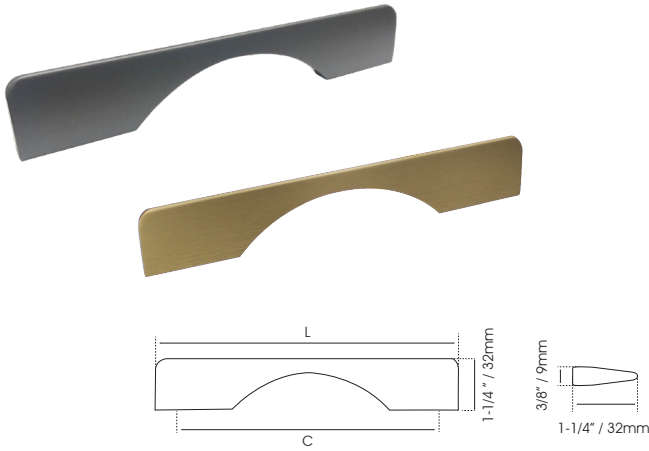

Material: Aluminum / Aluminio

CODE / CÓDIGO	FINISH / ACABADO	C	L	
KKD1131-160MB	● Matt black / Negro mate	160mm (6-5/16")	190mm (7-1/2")	1/25
KKD1131-160LM	● Brush gold / Dorado	160mm (6-5/16")	190mm (7-1/2")	1/25
KKD1131-160G	● Grey / Gris	160mm (6-5/16")	190mm (7-1/2")	1/25



PARBAT

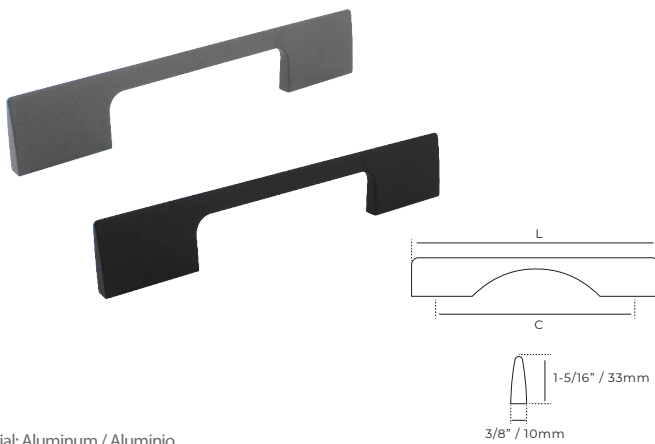

Material: Aluminum / Aluminio

CODE / CÓDIGO	FINISH / ACABADO	C	L	
KKD1100-160MB	● Matt black / Negro mate	160mm (6-5/16")	190mm (7-1/2")	1/25
KKD1100-160LM	● Brush gold / Dorado	160mm (6-5/16")	190mm (7-1/2")	1/25
KKD1100-160G	● Grey / Gris	160mm (6-5/16")	190mm (7-1/2")	1/25





NUPTSE

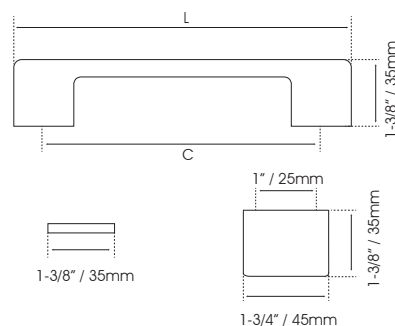
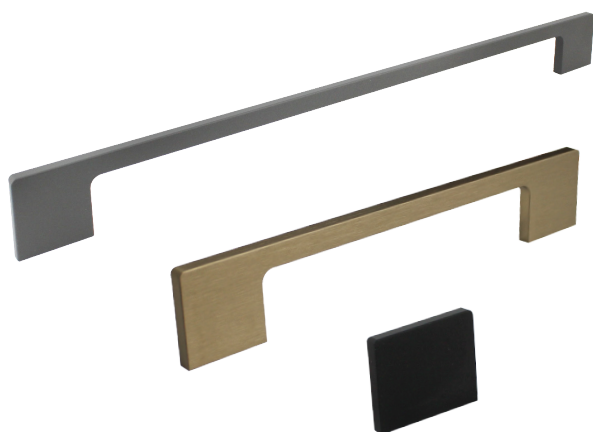

Material: Aluminum / Aluminio

CODE / CÓDIGO	FINISH / ACABADO	C	L	
KKD1084-25MB	● Matt black / Negro mate	25mm (1")	45mm (1-3/4")	1/20
KKD1084-25LM	● Brush gold / Dorado	25mm (1")	45mm (1-3/4")	1/20
KKD1084-25G	● Grey / Gris	25mm (1")	45mm (1-3/4")	1/20
KKD1084-160MB	● Matt black / Negro mate	160mm (6-5/16")	190mm (7-1/2")	1/30
KKD1084-160LM	● Brush gold / Dorado	160mm (6-5/16")	190mm (7-1/2")	1/30
KKD1084-160G	● Grey / Gris	160mm (6-5/16")	190mm (7-1/2")	1/30
KKD1084-320MB	● Matt black / Negro mate	320mm (12-5/8")	350mm (13-3/4")	1/25
KKD1084-320LM	● Brush gold / Dorado	320mm (12-5/8")	350mm (13-3/4")	1/25
KKD1084-320G	● Grey / Gris	320mm (12-5/8")	350mm (13-3/4")	1/25

All measurements are approximate / Las medidas son aproximadas

OYU

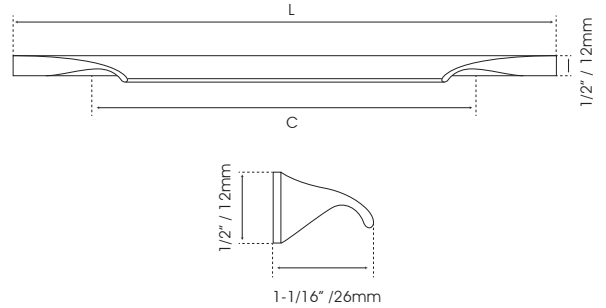

Material: Aluminum / Aluminio

CODE / CÓDIGO	FINISH / ACABADO	C	L	
KKD1064-290MB	● Matt black / Negro mate	160mm (6-5/16")	290mm (11-7/16")	1/25
KKD1064-290LM	● Brush gold / Dorado	160mm (6-5/16")	290mm (11-7/16")	1/25
KKD1064-290G	● Grey / Gris	160mm (6-5/16")	290mm (11-7/16")	1/25
KKD1064-390MB	● Matt black / Negro mate	256mm(10-1/16")	390mm (15-3/8")	1/30
KKD1064-390LM	● Brush gold / Dorado	256mm(10-1/16")	390mm (15-3/8")	1/30
KKD1064-390G	● Grey / Gris	256mm(10-1/16")	390mm (15-3/8")	1/30



MANASLU

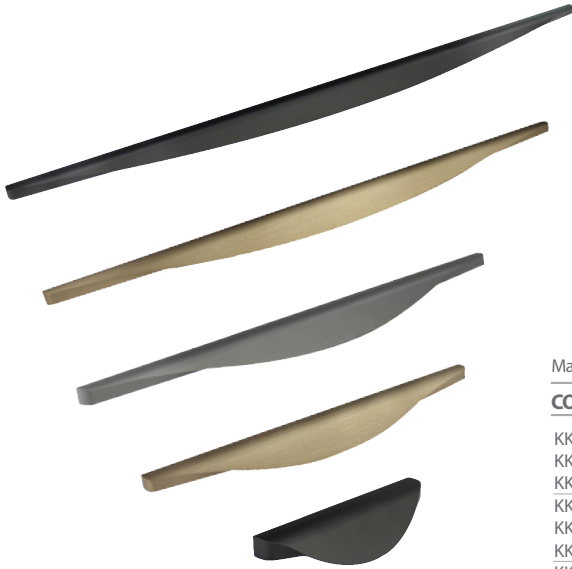

COD.
KKD1072-100
KKD1072-240
KKD1072-330

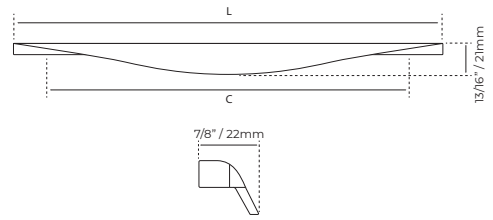

COD.
KKD1072-450
KKD1072-600

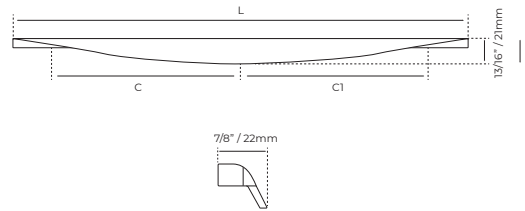

Material: Aluminum / Aluminio

CODE / CÓDIGO	FINISH / ACABADO	C	C1	L	
KKD1072-100MB	● Matt black / Negro mate	64mm (2-1/2")	-	100mm (4")	1/50
KKD1072-100LM	● Brush gold / Dorado	64mm (2-1/2")	-	100mm (4")	1/50
KKD1072-100G	● Grey / Gris	64mm (2-1/2")	-	100mm (4")	1/50
KKD1072-240MB	● Matt black / Negro mate	160mm (6-5/16")	-	240mm (9-7/16")	1/25
KKD1072-240LM	● Brush gold / Dorado	160mm (6-5/16")	-	240mm (9-7/16")	1/25
KKD1072-240G	● Grey / Gris	160mm (6-5/16")	-	240mm (9-7/16")	1/25
KKD1072-330MB	● Matt black / Negro mate	224mm (8-13/16")	-	330mm (13")	1/25
KKD1072-330LM	● Brush gold / Dorado	224mm (8-13/16")	-	330mm (13")	1/25
KKD1072-330G	● Grey / Gris	224mm (8-13/16")	-	330mm (13")	1/25
KKD1072-450MB	● Matt black / Negro mate	160mm (6-5/162)	160mm (6-5/162)	450mm (17-11/16")	1/25
KKD1072-450LM	● Brush gold / Dorado	160mm (6-5/162)	160mm (6-5/162)	450mm (17-11/16")	1/25
KKD1072-450G	● Grey / Gris	160mm (6-5/162)	160mm (6-5/162)	450mm (17-11/16")	1/25
KKD1072-600MB	● Matt black / Negro mate	256mm (10-1/16")	256mm (10-1/16")	600mm (23-5/8")	1/25
KKD1072-600LM	● Brush gold / Dorado	256mm (10-1/16")	256mm (10-1/16")	600mm (23-5/8")	1/25
KKD1072-600G	● Grey / Gris	256mm (10-1/16")	256mm (10-1/16")	600mm (23-5/8")	1/25



NANGA

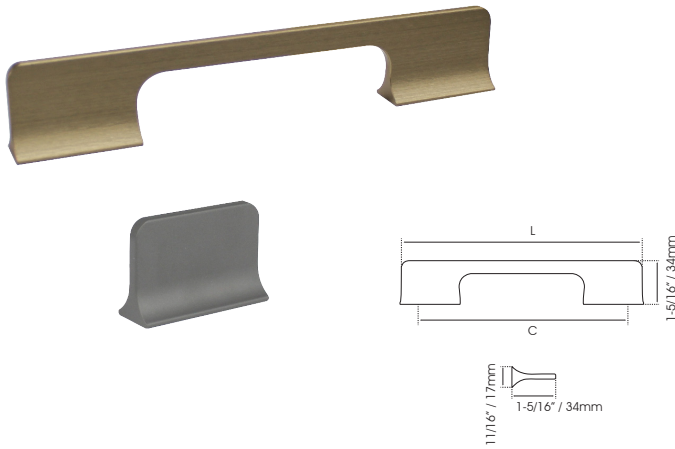

Material: Aluminum / Aluminio

CODE / CÓDIGO	FINISH / ACABADO	C	L	☒
KKD1099-50MB	● Matt black / Negro mate	32mm (1-1/4")	50mm (2")	1/50
KKD1099-50LM	● Brush gold / Dorado	32mm (1-1/4")	50mm (2")	1/50
KKD1099-50G	● Grey / Gris	32mm (1-1/4")	50mm (2")	1/50
KKD1099-160MB	● Matt black / Negro mate	160mm (6-5/16")	190mm (7-1/2")	1/20
KKD1099-160LM	● Brush gold / Dorado	160mm (6-5/16")	190mm (7-1/2")	1/20
KKD1099-160G	● Grey / Gris	160mm (6-5/16")	190mm (7-1/2")	1/20



SHISA

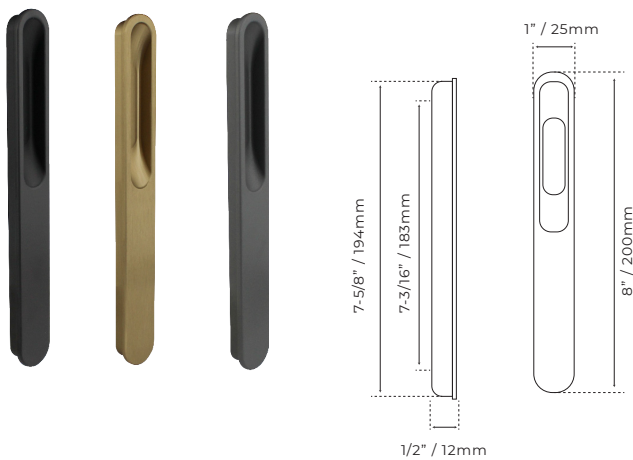

Material: Aluminum / Aluminio

CODE / CÓDIGO	FINISH / ACABADO	C	L	☒
KKD1097-200MB	● Matt black / Negro mate	183mm (7-3/16")	200mm (7-7/8")	1/25
KKD1097-200LM	● Brush gold / Dorado	183mm (7-3/16")	200mm (7-7/8")	1/25
KKD1097-200G	● Grey / Gris	183mm (7-3/16")	200mm (7-7/8")	1/25



All measurements are approximate / Las medidas son aproximadas



PANGMA

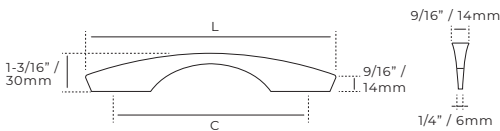

Material: Aluminum / Aluminio

CODE / CÓDIGO	FINISH / ACABADO	C	L	
KKD1201-160MB	● Matt black / Negro mate	160mm (6-5/16")	190mm (7-1/2")	1/25
KKD1201-160LM	● Brush gold / Dorado	160mm (6-5/16")	190mm (7-1/2")	1/25
KKD1201-160G	● Grey / Gris	160mm (6-5/16")	190mm (7-1/2")	1/25

KANG

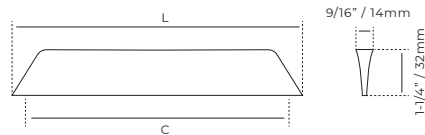
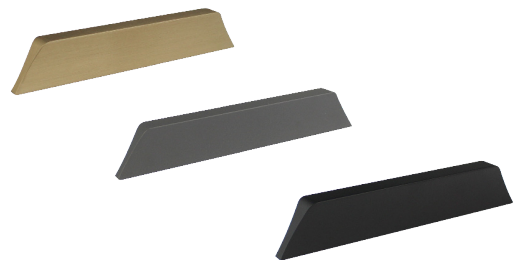

Material: Aluminum / Aluminio

CODE / CÓDIGO	FINISH / ACABADO	C	L	
KKD1079-160MB	● Matt black / Negro mate	160mm (6-5/16")	190mm (7-1/2")	1/20
KKD1079-160LM	● Brush gold / Dorado	160mm (6-5/16")	190mm (7-1/2")	1/20
KKD1079-160G	● Grey / Gris	160mm (6-5/16")	190mm (7-1/2")	1/20

CHULI

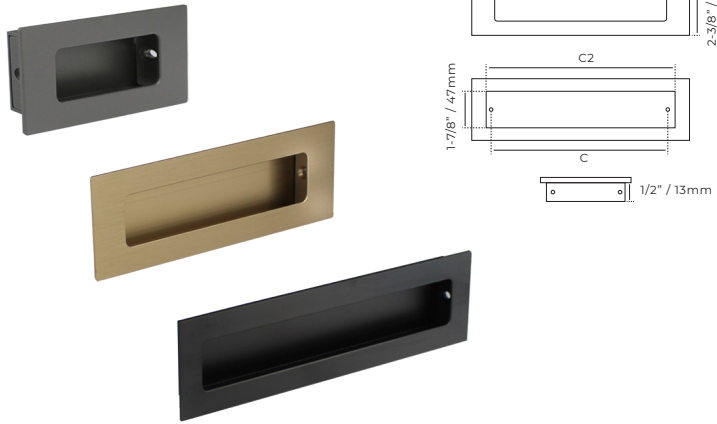

Material: Aluminum / Aluminio

CODE / CÓDIGO	FINISH / ACABADO	C	C2	L	
KKD1081-96MB	● Matt black / Negro mate	96mm (3-3/4")	103mm (4-1/16")	124mm (4-7/8")	1/20
KKD1081-96LM	● Brush gold / Dorado	96mm (3-3/4")	103mm (4-1/16")	124mm (4-7/8")	1/20
KKD1081-96G	● Grey / Gris	96mm (3-3/4")	103mm (4-1/16")	124mm (4-7/8")	1/20
KKD1081-160MB	● Matt black / Negro mate	160mm (6-5/16")	168mm (6-5/8")	188mm (7-3/8")	1/20
KKD1081-160LM	● Brush gold / Dorado	160mm (6-5/16")	168mm (6-5/8")	188mm (7-3/8")	1/20
KKD1081-160G	● Grey / Gris	160mm (6-5/16")	168mm (6-5/8")	188mm (7-3/8")	1/20
KKD1081-288MB	● Matt black / Negro mate	288mm (11-5/16")	296mm (11-5/8")	316mm (12-7/16")	1/20
KKD1081-288LM	● Brush gold / Dorado	288mm (11-5/16")	296mm (11-5/8")	316mm (12-7/16")	1/20
KKD1081-288G	● Grey / Gris	288mm (11-5/16")	296mm (11-5/8")	316mm (12-7/16")	1/20



DEVI

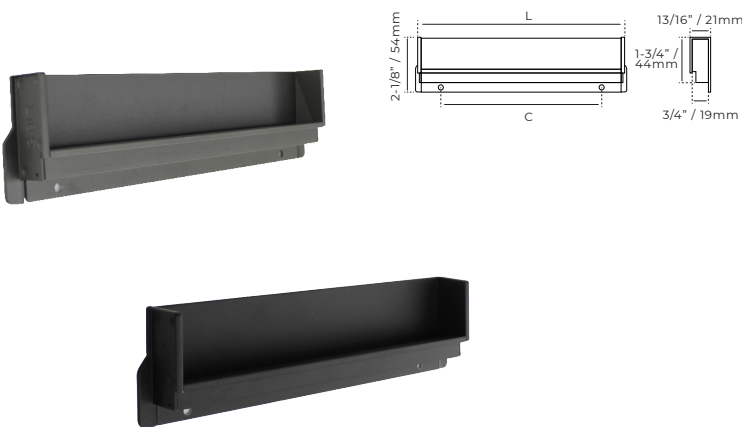

Material: Aluminum / Aluminio

CODE / CÓDIGO	FINISH / ACABADO	C	L	
KKD2124-200MB	● Matt black / Negro mate	160mm (6-5/16")	200mm (7-7/8")	1/25
KKD2124-200G	● Grey / Gris	160mm (6-5/16")	200mm (7-7/8")	1/25



PARBAT

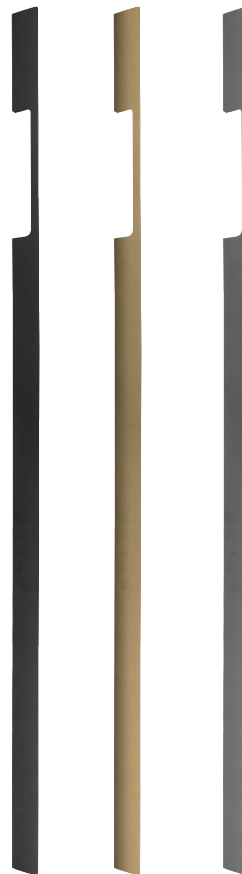

Material: Aluminum / Aluminio

CODE / CÓDIGO	FINISH / ACABADO	
KKD1100-1000MB	● Matt black / Negro mate	1/20
KKD1100-1000LM	● Brush gold / Dorado	1/20
KKD1100-1000G	● Grey / Gris	1/20

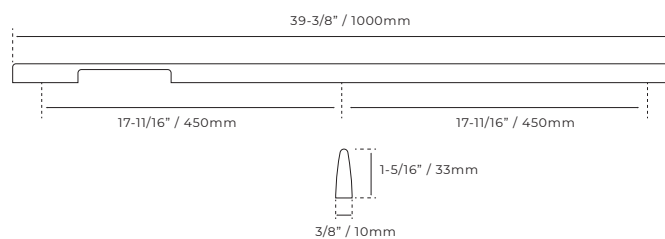



NANGA



Material: Aluminum / Aluminio

CODE / CÓDIGO	FINISH / ACABADO	
KKD1099-1000MB	● Matt black / Negro mate	1/20
KKD1099-1000LM	● Brush gold / Dorado	1/20
KKD1099-1000G	● Grey / Gris	1/20

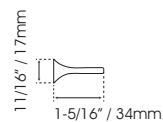
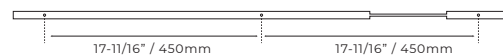
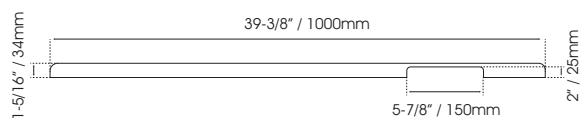

BROAD



Material: Aluminum / Aluminio

CODE / CÓDIGO	FINISH / ACABADO	
KKD1131-1000MB	● Matt black / Negro mate	1/20
KKD1131-1000LM	● Brush gold / Dorado	1/20
KKD1131-1000G	● Grey / Gris	1/20

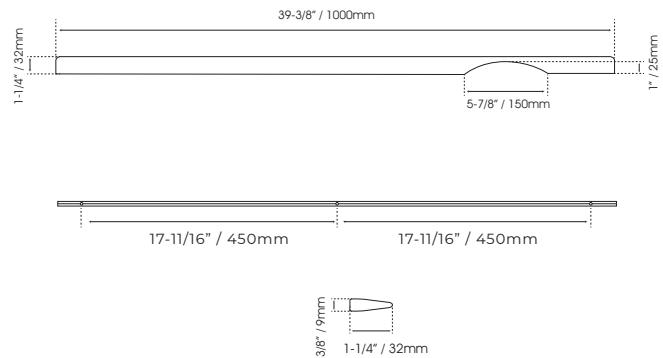

All measurements are approximate / Las medidas son aproximadas

BROAD



Material: Aluminum / Aluminio

CODE / CÓDIGO	FINISH / ACABADO	
KKD1131-2400MB	● Matt black / Negro mate	
KKD1131-2400LM	● Brush gold / Dorado	

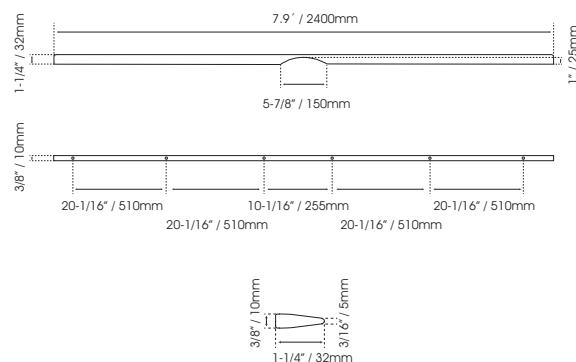



SHISA



Material: Aluminum / Aluminio

CODE / CÓDIGO	FINISH / ACABADO	C1	C2
KKD1097-600MB	● Matt black / Negro mate	11-7/16" / 290mm	11-1/2" / 292mm
KKD1097-600LM	● Brush gold / Dorado	11-7/16" / 290mm	11-1/2" / 292mm
KKD1097-600G	● Grey / Gris	11-7/16" / 290mm	11-1/2" / 292mm
KKD1097-900MB	● Matt black / Negro mate	17-3/8" / 442mm	17-3/8" / 442mm
KKD1097-900LM	● Brush gold / Dorado	17-3/8" / 442mm	17-3/8" / 442mm
KKD1097-900G	● Grey / Gris	17-3/8" / 442mm	17-3/8" / 442mm
KKD1097-1200MB	● Matt black / Negro mate	23-1/4" / 592mm	23-3/8" / 594mm
KKD1097-1200LM	● Brush gold / Dorado	23-1/4" / 592mm	23-3/8" / 594mm
KKD1097-1200G	● Grey / Gris	23-1/4" / 592mm	23-3/8" / 594mm

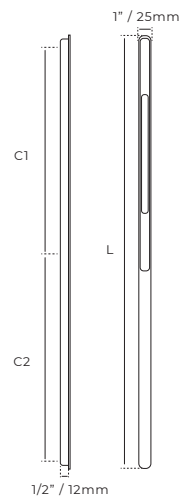

LARGO	⊠
23-5/8" / 600mm	1/20
23-5/8" / 600mm	1/20
23-5/8" / 600mm	1/20
35-7/16" / 900mm	1/20
35-7/16" / 900mm	1/20
35-7/16" / 900mm	1/20
47-1/4" / 1200mm	1/20
47-1/4" / 1200mm	1/20
47-1/4" / 1200mm	1/20

KANG

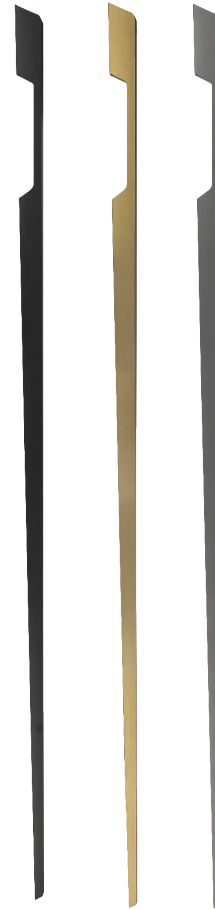

Material: Aluminum / Aluminio

CODE / CÓDIGO	FINISH / ACABADO	
KKD1079-1000MB	● Matt black / Negro mate	1/20
KKD1079-1000LM	● Brush gold / Dorado	1/20
KKD1079-1000G	● Grey / Gris	1/20

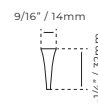
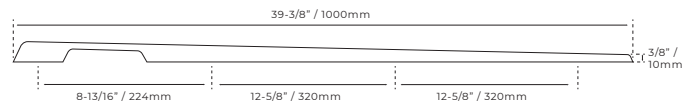

DEVI



Material: Aluminum / Aluminio

CODE / CÓDIGO	FINISH / ACABADO	
KKD2124-1100MB	● Matt black / Negro mate	1/15
KKD2124-1100G	● Gray / Gris	1/15

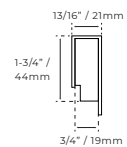
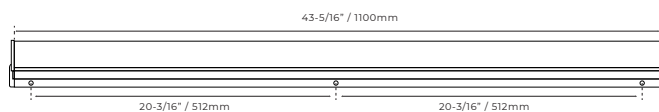

PANGMA



Material: Aluminum / Aluminio

CODE / CÓDIGO	FINISH / ACABADO	
KKD1201-1000MB	● Matt black / Negro mate	1/20
KKD1201-1000LM	● Brush gold / Dorado	1/20
KKD1201-1000G	● Grey / Gris	1/20

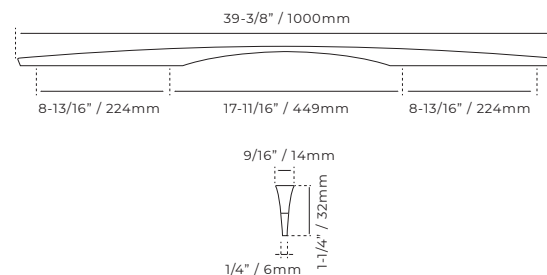

All measurements are approximate / Las medidas son aproximadas

WIN350

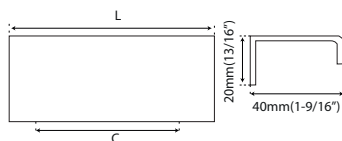
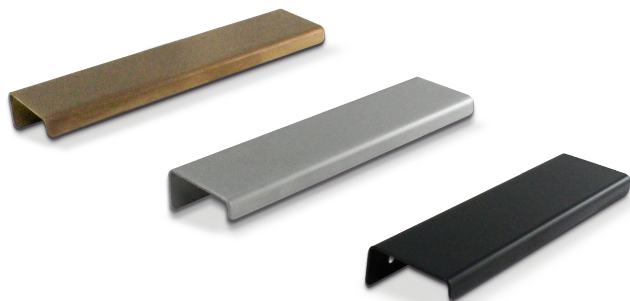

Material: Aluminum / Aluminio

CODE / CÓDIGO	FINISH / ACABADO	C	L	
WIN35025GG	● Titanium/Titanio	25mm(1")	44mm(1-3/4")	50/500
WIN35025MB	● Black/Negro	25mm(1")	44mm(1-3/4")	50/500
WIN35025MTG	● Matt Brass/ Latón Mate	25mm(1")	44mm(1-3/4")	50/500
WIN35096GG	● Titanium/Titanio	66mm(2-5/8")	96mm(3-3/4")	25/200
WIN35096MB	● Black/Negro	66mm(2-5/8")	96mm(3-3/4")	25/200
WIN35096MTG	● Matt Brass/ Latón Mate	66mm(2-5/8")	96mm(3-3/4")	25/200
WIN350128GG	● Titanium/Titanio	96mm(3-3/4")	128mm(5-1/16")	20/200
WIN350128MB	● Black/Negro	96mm(3-3/4")	128mm(5-1/16")	20/200
WIN350128MTG	● Matt Brass/ Latón Mate	96mm(3-3/4")	128mm(5-1/16")	20/200
WIN350160GG	● Titanium/Titanio	128mm(5-1/16")	160mm(6-5/16")	15/150
WIN350160MB	● Black/Negro	128mm(5-1/16")	160mm(6-5/16")	15/150
WIN350160MTG	● Matt Brass/ Latón Mate	128mm(5-1/16")	160mm(6-5/16")	15/150
WIN350224GG	● Titanium/Titanio	192mm(7-9/16")	224mm(8-13/16")	20/200
WIN350224MB	● Black/Negro	192mm(7-9/16")	224mm(8-13/16")	20/200
WIN350224MTG	● Matt Brass/ Latón Mate	192mm(7-9/16")	224mm(8-13/16")	20/200
WIN3501000GG	● Titanium/Titanio	970mm(38-3/16")	1000mm(39-3/8")	20/200
WIN3501000MB	● Black/Negro	970mm(38-3/16")	1000mm(39-3/8")	20/200
WIN3501000MTG	● Matt Brass/ Latón Mate	970mm(38-3/16")	1000mm(39-3/8")	20/200



ESPAÑA

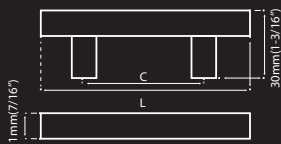
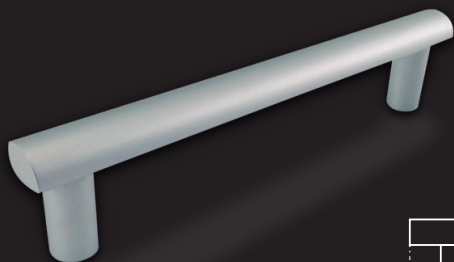

Material: Aluminum / Aluminio

CODE / CÓDIGO	FINISH / ACABADO	C	L	
EM001-096-ESPAÑA	● Aluminum/Aluminio	96mm (3-3/4")	118mm (4-5/8")	35/210
EM001-128-ESPAÑA	● Aluminum/Aluminio	128mm (5-1/16")	150mm (5-7/8")	30/180
EM001-224-ESPAÑA	● Aluminum/Aluminio	224mm (8-13/16")	350mm (13-3/4")	20/80
EM001-256-ESPAÑA	● Aluminum/Aluminio	256mm (10-1/16")	399mm (15-11/16")	20/80

SUIZA

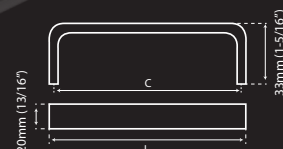
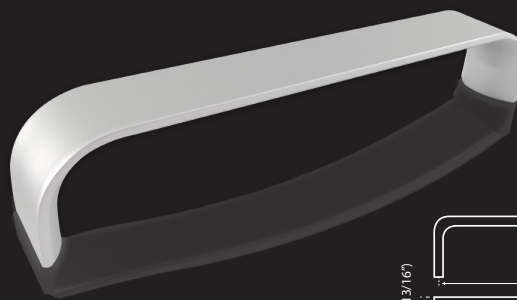

Material: Aluminum / Aluminio

CODE / CÓDIGO	FINISH / ACABADO	C	L	
EM031-096-SUIZA	● Aluminum/Aluminio	96mm (3-3/4")	103mm (4-1/16")	35/210
EM031-128-SUIZA	● Aluminum/Aluminio	128mm (5-1/16")	135mm (4-1/16")	30/180

MAROCCO

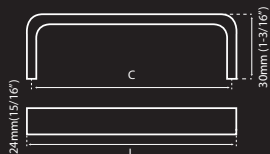
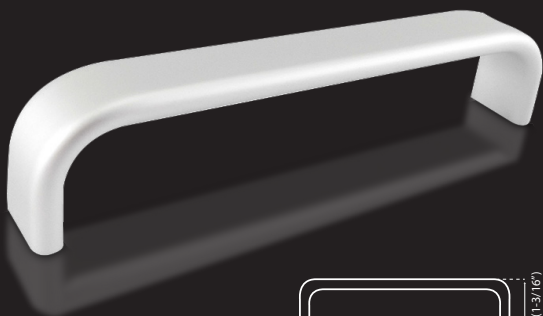

Material: Aluminum / Aluminio

CODE / CÓDIGO	FINISH / ACABADO	C	L	
EM012-096-MAROCCO	● Aluminum/Aluminio	96mm (3-3/4")	102mm (4")	30/180
EM012-128-MAROCCO	● Aluminum/Aluminio	128mm (5-1/16")	135mm (5-5/16")	25/150
EM012-160-MAROCCO	● Aluminum/Aluminio	160mm (6-5/16")	167mm (6-9/16")	20/120
EM012-224-MAROCCO	● Aluminum/Aluminio	224mm (4-7/8")	231mm (9-1/8")	20/80
EM012-320-MAROCCO	● Aluminum/Aluminio	320mm (12-5/8")	327mm (12-7/8")	20/80
EM012-384-MAROCCO	● Aluminum/Aluminio	384mm (15-1/8")	391mm (15-3/8")	20/80
EM012-096-MAROCCOBLACK	○ Black/Negro	96mm (3-3/4")	102mm (4")	30/180
EM012-128-MAROCCOBLACK	○ Black/Negro	128mm (5-1/16")	135mm (5-5/16")	25/150
EM012-160-MAROCCOBLACK	○ Black/Negro	160mm (6-5/16")	167mm (6-9/16")	20/120
EM012-224-MAROCCOBLACK	○ Black/Negro	224mm (4-7/8")	231mm (9-1/8")	20/80
EM012-320-MAROCCOBLACK	○ Black/Negro	320mm (12-5/8")	327mm (12-7/8")	20/80
EM012-320-MAROCCOMTG	● Matt Brass/Latón Mate	320mm (12-5/8")	327mm (12-7/8")	20/80

CANADÁ

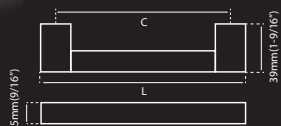
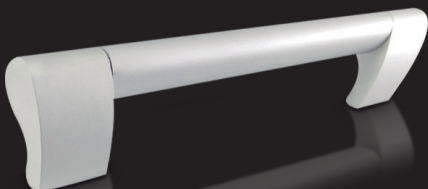

Material: Aluminum / Aluminio

CODE / CÓDIGO	FINISH / ACABADO	C	L	
EM035-096-CANADA	● Aluminum/Aluminio	96mm (3-3/4")	115mm (4-1/2")	30/180
EM035-128-CANADA	● Aluminum/Aluminio	128mm (5-1/16")	147mm (5-13/16")	25/150

MÉXICO

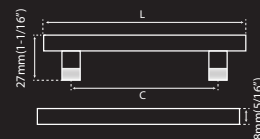
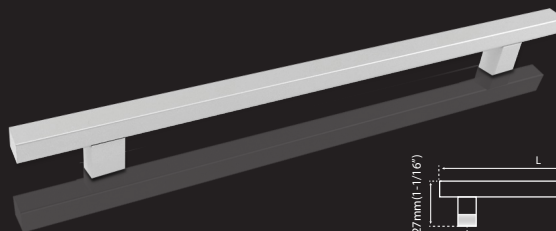

Material: Aluminum / Aluminio

CODE / CÓDIGO	FINISH / ACABADO	C	L	
EM072-096-MEXICO	● Aluminum/Aluminio	96mm (3-3/4")	147mm (5-13/16")	35/210
EM072-128-MEXICO	● Aluminum/Aluminio	128mm (5-1/16")	179mm (7-1/16")	35/210
EM072-160-MEXICO	● Aluminum/Aluminio	160mm (6-5/16")	211mm (8-5/16")	80/180
EM072-224-MEXICO	● Aluminum/Aluminio	224mm (8-13/16")	275mm (10-13/16")	25/150
EM072-384-MEXICO	● Aluminum/Aluminio	384mm (15-1/8")	435mm (17-1/8")	20/120

ALEMANIA

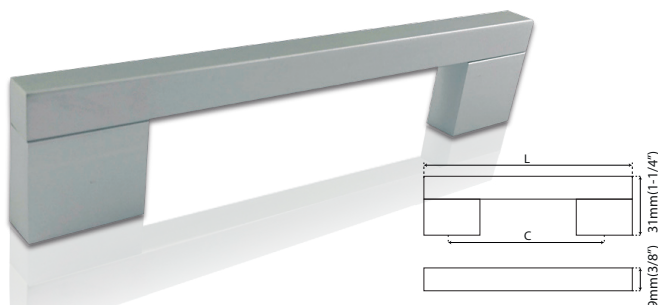

Material: Aluminum / Aluminio

CODE / CÓDIGO	FINISH / ACABADO	C	L	
EM086-096-ALEMANIA	● Aluminum/Aluminio	96mm (3-3/4")	113mm (4-7/16")	40/240
EM086-128-ALEMANIA	● Aluminum/Aluminio	128mm (5-1/16")	145mm (5-11/16")	30/180

GRECIA

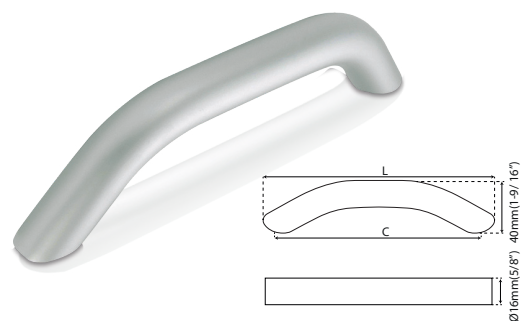

Material: Aluminum / Aluminio

CODE / CÓDIGO	FINISH / ACABADO	C	L	
EM123-096-GRECIA	● Aluminum/Aluminio	96mm (3-3/4")	126mm (4-15/16")	30/180
EM123-128-GRECIA	● Aluminum/Aluminio	128mm (5-1/16")	160mm (6-5/16")	25/150

CROACIA

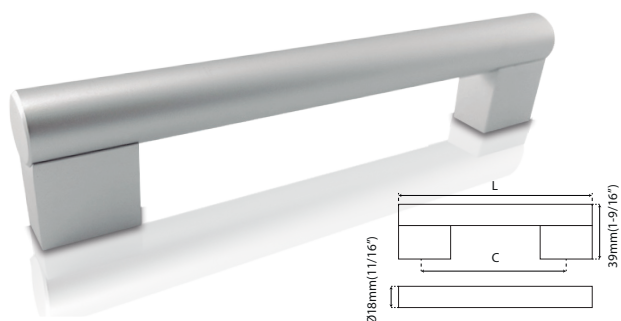

Material: Aluminum / Aluminio

CODE / CÓDIGO	FINISH / ACABADO	C	L	
EM113-096-CROACIA	● Aluminum/Aluminio	96mm (3-3/4")	110mm (4-5/16")	20/120
EM113-128-CROACIA	● Aluminum/Aluminio	128mm (5-1/16")	141mm (5-9/16")	20/80
EM113-160-CROACIA	● Aluminum/Aluminio	160mm (6-5/16")	174mm (6-7/8")	20/80
EM113-320-CROACIA	● Aluminum/Aluminio	320mm (12-5/8")	360mm (14-3/16")	20/80

NIGERIA

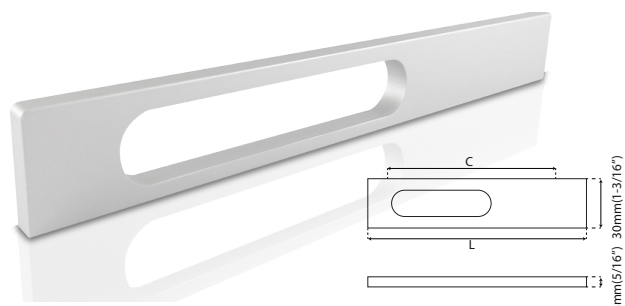

Material: Aluminum / Aluminio

CODE / CÓDIGO	FINISH / ACABADO	C	L	
EM139-192-NIGERIA	● Aluminum/Aluminio	192mm (7-9/16")	255mm (10-1/16")	25/100
EM139-320-NIGERIA	● Aluminum/Aluminio	320mm (12-5/8")	383mm (15-1/16")	25/100



PERÚ

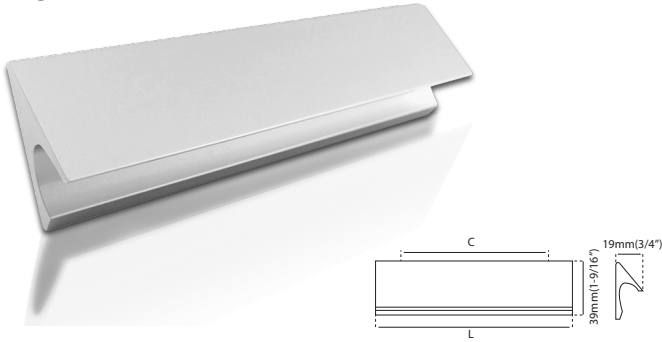

Material: Aluminum / Aluminio

CODE / CÓDIGO	FINISH / ACABADO	C	L	
EM149-096-PERU	● Aluminum/Aluminio	96mm (3-3/4")	120mm (4-3/4")	30/180
EM149-128-PERU	● Aluminum/Aluminio	128mm (5-1/16")	150mm (5-7/8")	25/150
EM149-160-PERU	● Aluminum/Aluminio	160mm (6-5/16")	200mm (7-7/8")	20/120
EM149-320-PERU	● Aluminum/Aluminio	320mm (12-5/8")	400mm (15-3/4")	20/80

INDONESIA

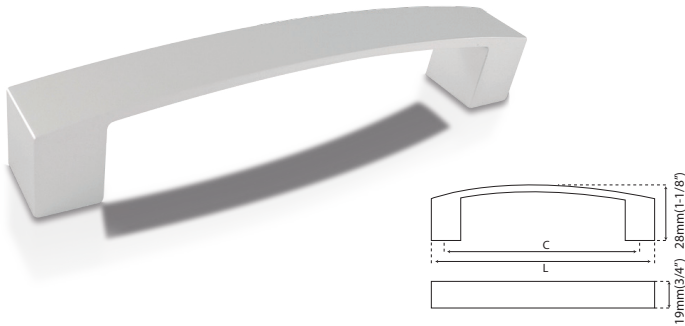

Material: Aluminum / Aluminio

CODE / CÓDIGO	FINISH / ACABADO	C	L	
EM162-128-INDONESIA	● Aluminum/Aluminio	128mm (5-1/16")	145mm (5-11/16")	25/150

TURQUÍA



Material: Aluminum / Aluminio

CODE / CÓDIGO	FINISH / ACABADO	C	L	
EM172-160-TURQUIA	● Bright Aluminum/Aluminio Brillo	160 mm (6-5/16")	190mm (7-1/2")	25/150

CHILE



Material: Aluminum / Aluminio

CODE / CÓDIGO	FINISH / ACABADO	C	L	
EM085-096-CHILE	● Aluminum/Aluminio	96mm (3-13/16")	117mm (4-5/8")	50/300
EM085-128-CHILE	● Aluminum/Aluminio	128mm (5-1/16")	155mm (6-1/8")	50/300
EM085-160-CHILE	● Aluminum/Aluminio	160mm (6-5/16")	193mm (7-5/8")	40/240





FRANCIA

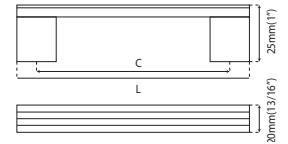
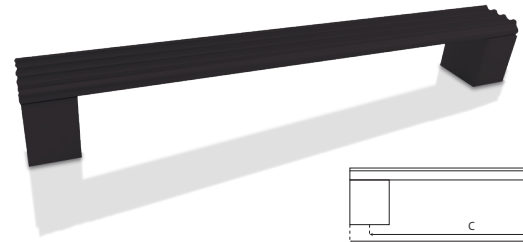

Material: Aluminum / Aluminio

CODE / CÓDIGO	FINISH / ACABADO	C	L	
EM036-128-FRANCIA	● Aluminum/Aluminio	128mm (5-1/16")	143mm (5-5/8")	25/150
EM036-160-FRANCIA	● Aluminum/Aluminio	160mm (6-5/16")	175mm (6-7/8")	25/150
EM036-128-FRANCIAMB	● Black/Negro	128mm (5-1/16")	143mm (5-5/8")	25/150
EM036-160-FRANCIAMB	● Black/Negro	160mm (6-5/16")	175mm (6-7/8")	25/150

ARGENTINA

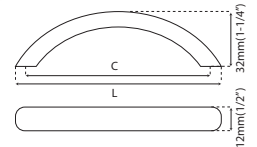

Material: Aluminum / Aluminio

CODE / CÓDIGO	FINISH / ACABADO	C	L	
EM043-096-ARGENTINA	● Aluminum/Aluminio	96mm (3-13/16")	120mm (4-3/4")	40/240
EM043-128-ARGENTINA	● Aluminum/Aluminio	128mm (5-1/16")	158mm (6-1/4")	30/180
EM043-096-ARGENTINAMB	● Black/Negro	96mm (3-13/16")	120mm (4-3/4")	40/240
EM043-128-ARGENTINAMB	● Black/Negro	128mm (5-1/16")	158mm (6-1/4")	30/180

FINLANDIA

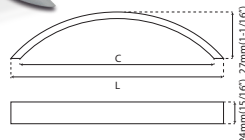
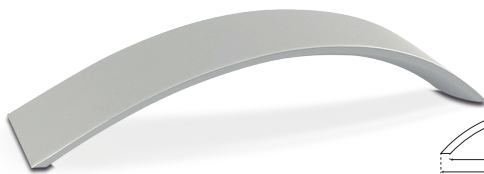

Material: Aluminum / Aluminio

CODE / CÓDIGO	FINISH / ACABADO	C	L	
EM008-096-FINLANDIA	● Aluminum/Aluminio	96mm (3-3/4")	118mm (4-5/8")	40/240
EM008-128-FINLANDIA	● Aluminum/Aluminio	128mm (5-1/16")	149mm (5-7/8")	35/210

ITALIA

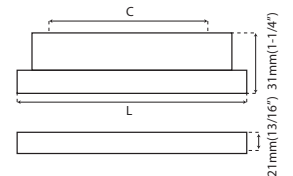
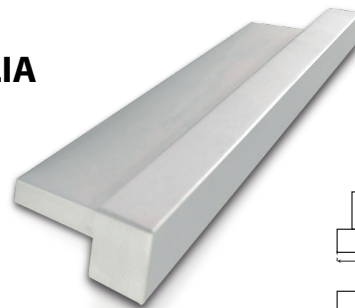

Material: Aluminum / Aluminio

CODE / CÓDIGO	FINISH / ACABADO	C	L	
EM081-096-ITALIA	● Aluminum/Aluminio	96mm (3-13/16")	120mm (4-3/4")	30/180
EM081-128-ITALIA	● Aluminum/Aluminio	128mm (5-1/16")	150mm (5-7/8")	25/150

INGLATERRA

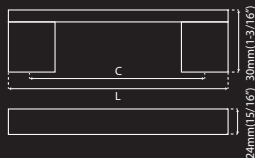
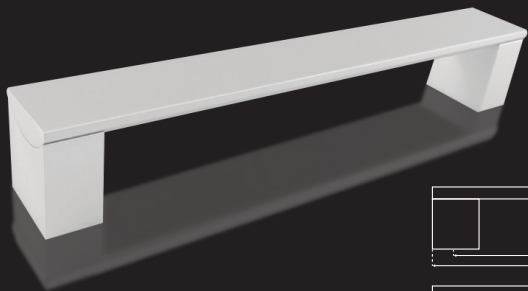

Material: Aluminum / Aluminio

CODE / CÓDIGO	FINISH / ACABADO	L	P	⊗
EM015-128-INGLATERRA	● Aluminum/Aluminio	128mm (5-1/16")	143mm (5-5/8")	20/120
EM015-160-INGLATERRA	● Aluminum/Aluminio	160mm (6-5/16")	174mm (6-7/8")	20/80
EM015-224-INGLATERRA	● Aluminum/Aluminio	224mm (8-13/16")	239mm (9-7/16")	20/80

COSTA RICA

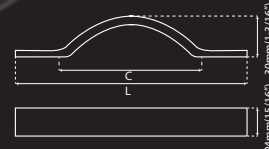
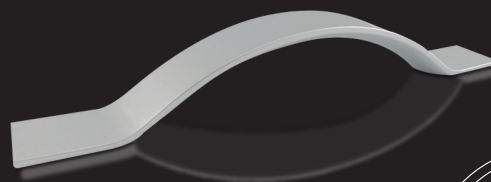

Material: Aluminum / Aluminio

CODE / CÓDIGO	FINISH / ACABADO	C	L	⊗
EM021-096-COSTARICA	● Aluminum/Aluminio	96mm (3-3/4")	167mm (6-9/16")	25/150
EM021-128-COSTARICA	● Aluminum/Aluminio	128mm (5-1/16")	202mm (7-15/16")	25/150
EM021-160-COSTARICA	● Aluminum/Aluminio	160mm (6-5/16")	234mm (9-3/16")	25/150

AUSTRIA

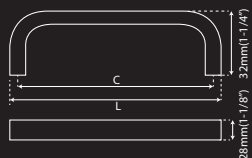
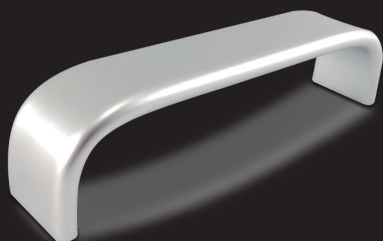

Material: Aluminum / Aluminio

CODE / CÓDIGO	FINISH / ACABADO	C	L	⊗
EM032-096-AUSTRIA	● Aluminum/Aluminio	96mm (3-3/4")	103mm (4-1/16")	25/150
EM032-128-AUSTRIA	● Aluminum/Aluminio	128mm (5-1/16")	134mm (5-1/4")	20/120
EM032-160-AUSTRIA	● Aluminum/Aluminio	160mm (6-5/16")	167mm (6-9/16")	20/120
EM032-224-AUSTRIA	● Aluminum/Aluminio	224mm (8-13/16")	231mm (9-1/8")	20/80

KENIA

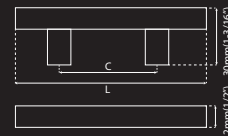
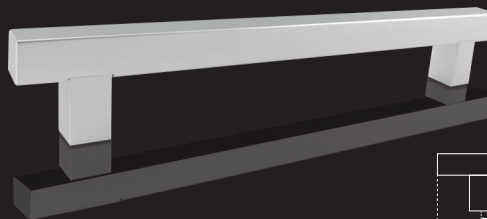

Material: Aluminum / Aluminio

CODE / CÓDIGO	FINISH / ACABADO	C	L	⊗
EM106-096-KENIA	● Aluminum/Aluminio	96mm (3-13/16")	134mm (5-1/4")	30/180
EM106-128-KENIA	● Aluminum/Aluminio	128mm (5-1/16")	167mm (6-9/16")	25/150
EM106-160-KENIA	● Aluminum/Aluminio	160mm (6-5/16")	198mm (7-13/16")	25/150
EM106-320-KENIA	● Aluminum/Aluminio	320mm (12-5/8")	359mm (14-1/8")	20/100

HAWÁI

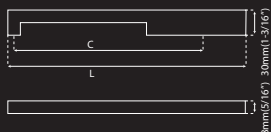
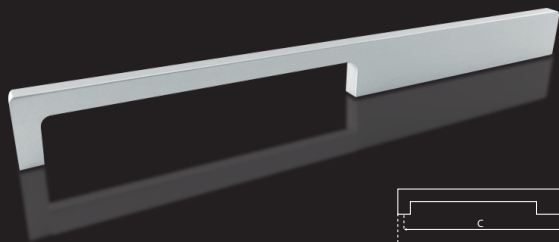

Material: Aluminum / Aluminio

CODE / CÓDIGO	FINISH / ACABADO	C	L	⊗
EM137-256-HAWAI	● Aluminum/Aluminio	256mm (10-1/16")	320mm (12-5/8")	25/100

SANMARINO

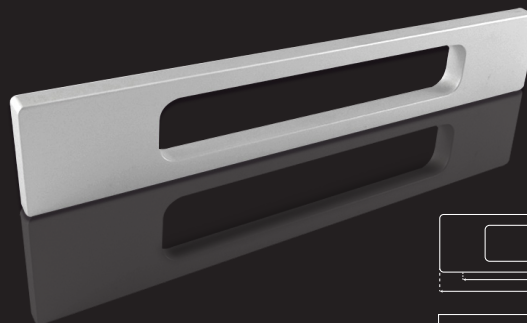

Material: Aluminum / Aluminio

CODE / CÓDIGO	FINISH / ACABADO	C	L	⊗
EM152-128-SANMARINO	● Aluminum/Aluminio	128mm (5-1/16")	148mm (5-13/16")	30/180
EM152-160-SANMARINO	● Aluminum/Aluminio	160mm (6-5/16")	188mm (7-3/8")	25/150



DENALI

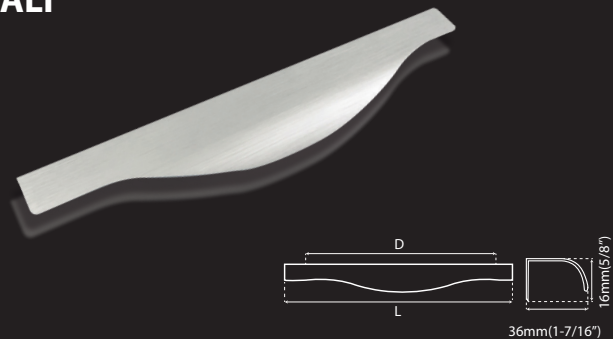

Material: Aluminum / Aluminio

CODE / CÓDIGO	FINISH / ACABADO	D	L	☒
KKD4003-197SS	● Aluminum/Aluminio	96mm (3-3/4")	197mm (7-3/4")	25/150
KKD4003-247SS	● Aluminum/Aluminio	147mm (5-13/16")	247mm (9-3/4")	25/100
KKD4003-347SS	● Aluminum/Aluminio	123mm (4-13/16")	347mm (13-11/16")	25/100
KKD4003-197MB	○ Black/Negro	96mm (3-3/4")	197mm (7-3/4")	25/150
KKD4003-247MB	○ Black/Negro	147mm (5-13/16")	247mm (9-3/4")	25/100
KKD4003-347MB	○ Black/Negro	123mm (4-13/16")	347mm (13-11/16")	25/100

ARUBA

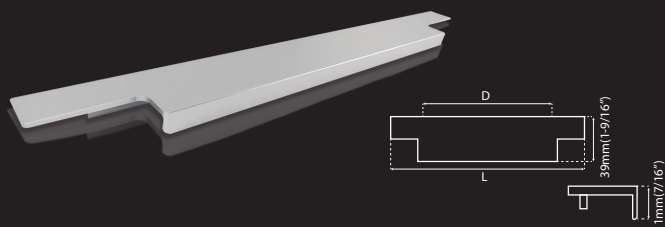

Material: Aluminum / Aluminio

CODE / CÓDIGO	FINISH / ACABADO	D	L	☒
F-ARUBA-147CM	● Matt Aluminum/Aluminio Mate	94mm (3-11/16")	147mm (5-13/16")	25/150
F-ARUBA-297CM	● Matt Aluminum/Aluminio Mate	250mm (9-13/16")	297mm (11-11/16")	25/100
F-ARUBA-347CM	● Matt Aluminum/Aluminio Mate	293mm (11-9/16")	347mm (13-11/16")	25/100
F-ARUBA-397CM	● Matt Aluminum/Aluminio Mate	348mm (13-11/16")	397mm (15-5/8")	25/100
F-ARUBA-147CB	● Bright Aluminum/Aluminio Brillo	94mm (3-11/16")	147mm (5-13/16")	25/150
F-ARUBA-297CB	● Bright Aluminum/Aluminio Brillo	250mm (9-13/16")	297mm (11-11/16")	25/100
F-ARUBA-347CB	● Bright Aluminum/Aluminio Brillo	293mm (11-9/16")	347mm (13-11/16")	25/100
F-ARUBA-397CB	● Bright Aluminum/Aluminio Brillo	348mm (13-11/16")	397mm (15-5/8")	25/100

EVEREST

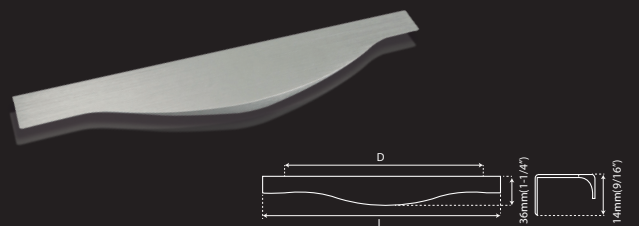

Material: Aluminum / Aluminio

CODE / CÓDIGO	FINISH / ACABADO	D	L	☒
KKD4001-197SS	● Aluminum/Aluminio	95mm (3-3/4")	197mm (7-3/4")	25/150
KKD4001-247SS	● Aluminum/Aluminio	152mm (6")	247mm (9-3/4")	25/100
KKD4001-347SS	● Aluminum/Aluminio	124mm (4-7/8")	347mm (13-11/16")	25/100
KKD4001-197MB	○ Matt Black/ Negro Mate	95mm (3-3/4")	197mm (7-3/4")	25/150
KKD4001-247MB	○ Matt Black/ Negro Mate	152mm (6")	247mm (9-3/4")	25/100
KKD4001-347MB	○ Matt Black/ Negro Mate	124mm (4-7/8")	347mm (13-11/16")	25/100

BAHAMAS

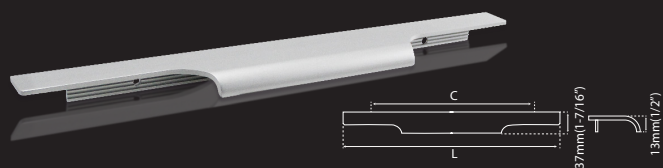

Material: Aluminum / Aluminio

CODE / CÓDIGO	FINISH / ACABADO	C	L	☒
KKD2003-147CB	● Bright Aluminum/Aluminio Brillo	75mm (2-15/16")	147mm (5-13/16")	20
KKD2003-297CB	● Bright Aluminum/Aluminio Brillo	180mm (7-1/16")	297mm (11-11/16")	20
KKD2003-347CB	● Bright Aluminum/Aluminio Brillo	233mm (9-3/16")	347mm (9-3/4")	20
KKD2003-397CB	● Bright Aluminum/Aluminio Brillo	226mm (8-7/8")	397mm (15-5/8")	20
KKD2003-147CM	● Matt Aluminum/Aluminio Mate	75mm (2-15/16")	147mm (5-13/16")	20
KKD2003-297CM	● Matt Aluminum/Aluminio Mate	180mm (7-1/16")	297mm (11-11/16")	20
KKD2003-347CM	● Matt Aluminum/Aluminio Mate	233mm (9-3/16")	347mm (9-3/4")	20
KKD2003-397CM	● Matt Aluminum/Aluminio Mate	226mm (8-7/8")	397mm (15-5/8")	20





FLORIDA

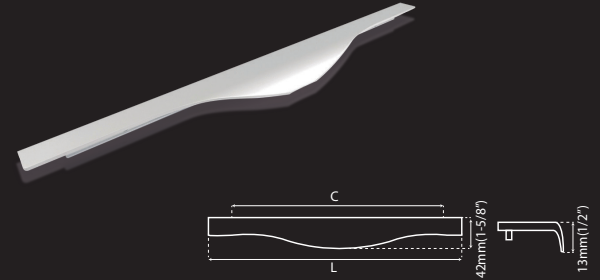

Material: Aluminum / Aluminio

CODE / CÓDIGO	FINISH / ACABADO	C	L	
KKD2113-147CM	● Matte Aluminum/Aluminio Mate	80mm(3-1/8")	147mm(5-13/16")	30/180
KKD2113-297CM	● Matte Aluminum/Aluminio Mate	133mm(5-1/4")	297mm(11-11/16")	30/180
KKD2113-347CM	● Matte Aluminum/Aluminio Mate	228mm(9")	347mm(13-11/16")	25/100
KKD2113-397CM	● Matte Aluminum/Aluminio Mate	280mm(11")	397mm(15-5/8")	25/100
KKD2113-147CB	● Bright Aluminum/Aluminio Brillo	80mm(3-1/8")	147mm(5-13/16")	25/100
KKD2113-297CB	● Bright Aluminum/Aluminio Brillo	133mm(5-1/4")	297mm(11-11/16")	25/100
KKD2113-347CB	● Bright Aluminum/Aluminio Brillo	228mm(9")	347mm(13-11/16")	25/100
KKD2113-397CB	● Bright Aluminum/Aluminio Brillo	280mm(11")	397mm(15-5/8")	25/100

TRINIDAD

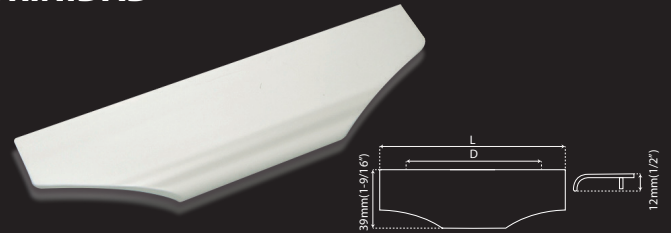

Material: Aluminum / Aluminio

CODE / CÓDIGO	FINISH / ACABADO	D	L	
KKD2104-147CM	● Matte Aluminum/Aluminio Mate	74mm(2-15/16")	147mm(5-13/16")	30/180
KKD2104-297CM	● Matte Aluminum/Aluminio Mate	228mm(9")	297mm(11-11/16")	25/100
KKD2104-347CM	● Matte Aluminum/Aluminio Mate	228mm(9")	347mm(13-11/16")	25/100
KKD2104-397CM	● Matte Aluminum/Aluminio Mate	230mm(9-1/16")	397mm(15-5/8")	25/100
KKD2104-147CB	● Bright Aluminum/Aluminio Brillo	74mm(2-15/16")	147mm(5-13/16")	30/180
KKD2104-297CB	● Bright Aluminum/Aluminio Brillo	228mm(9")	297mm(11-11/16")	25/100
KKD2104-347CB	● Bright Aluminum/Aluminio Brillo	228mm(9")	347mm(13-11/16")	25/100
KKD2104-397CB	● Bright Aluminum/Aluminio Brillo	230mm(9-1/16")	397mm(15-5/8")	25/100

HAVANA

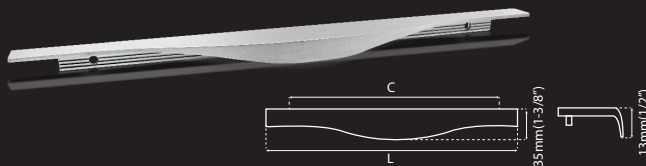

Material: Aluminum / Aluminio

CODE / CÓDIGO	FINISH / ACABADO	C	L	
KKD2100-147CB	● Bright Aluminum/Aluminio Brillo	53mm(2-1/16")	147mm(5-13/16")	20
KKD2100-297CB	● Bright Aluminum/Aluminio Brillo	203mm(8")	297mm(11-11/16")	20
KKD2100-347CB	● Bright Aluminum/Aluminio Brillo	254mm(10")	347mm(13-11/16")	20
KKD2100-397CB	● Bright Aluminum/Aluminio Brillo	317mm(12-1/2")	397mm(15-5/8")	20
KKD2100-147CM	● Matt Aluminum/Aluminio Mate	53mm(2-1/16")	147mm(5-13/16")	20
KKD2100-297CM	● Matt Aluminum/Aluminio Mate	203mm(8")	297mm(11-11/16")	20
KKD2100-347CM	● Matt Aluminum/Aluminio Mate	254mm(10")	347mm(13-11/16")	20
KKD2100-397CM	● Matt Aluminum/Aluminio Mate	317mm(12-1/2")	397mm(15-5/8")	20

ACONCAGUA

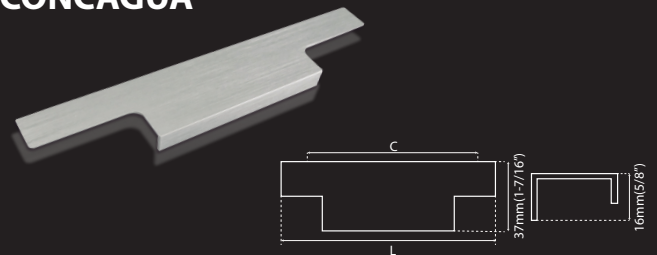

Material: Aluminum / Aluminio

CODE / CÓDIGO	FINISH / ACABADO	C	L	
KKD4002-197SS	● Aluminum/Aluminio	96mm(3-3/4")	197mm(7-3/4")	25/150
KKD4002-247SS	● Aluminum/Aluminio	146mm(5-3/4")	247mm(9-3/4")	25/100
KKD4002-347SS	● Aluminum/Aluminio	122mm(4-13/16")	347mm(13-11/16")	25/100
KKD4002-197MB	○ Black/Negro	96mm(3-3/4")	197mm(7-3/4")	25/150
KKD4002-247MB	○ Black/Negro	146mm(5-3/4")	247mm(9-3/4")	25/100
KKD4002-347MB	○ Black/Negro	122mm(4-13/16")	347mm(13-11/16")	25/100

RUSIA

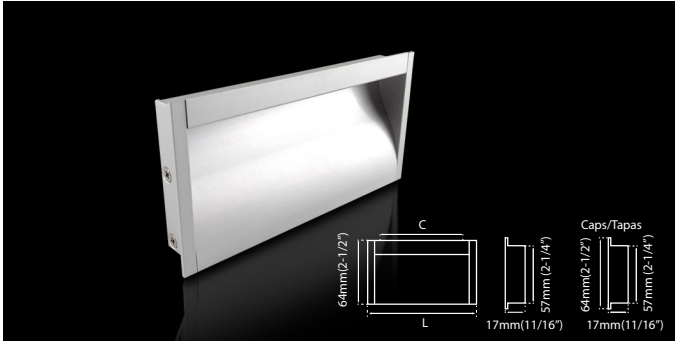

Material: Aluminum-Includes cut-out screws Material: Aluminio-Incluye tornillos recortables

CODE / CÓDIGO	FINISH / ACABADO	C	L	⊠
EM030-064-RUSIA	● Aluminum/Aluminio	64mm (2-1/2")	87mm (3-7/16")	25/150
EM030-096-RUSIA	● Aluminum/Aluminio	96mm (3-3/4")	127mm (5")	20/120
EM030-3000-RUSIA	● Aluminum/Aluminio	PROFILE / PERFIL	3000mm (118")	1/10
EM030-CAPS	● Aluminum/Aluminio	CAPS / TAPAS		1/200

ECUADOR

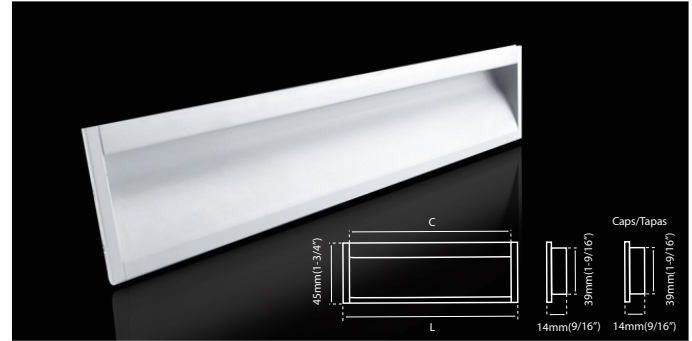

Material: Aluminum-Includes cut-out screws Material: Aluminio-Incluye tornillos recortables

CODE / CÓDIGO	FINISH / ACABADO	C	L	⊠
EM140-096-ECUADOR	● Aluminum/Aluminio	96mm (3-3/4")	125mm (4-15/16")	20/120
EM140-128-ECUADOR	● Aluminum/Aluminio	128mm (5-1/16")	155mm (6-1/8")	20/120
EM140-128-ECUADORMB	● Black/Negro	128mm (5-1/16")	155mm (6-1/8")	20/120
EM140-160-ECUADOR	● Aluminum/Aluminio	160mm (6-5/16")	205mm (8-1/16")	20/180
EM140-224-ECUADOR	● Aluminum/Aluminio	224mm (8-13/16")	305mm (12")	15/60
EM140-3000-ECUADOR	● Aluminum/Aluminio	PROFILE / PERFIL	3000mm (118")	1/12
EM140-CAPS	● Aluminum/Aluminio	CAPS / TAPAS		1/200

UCRANIA

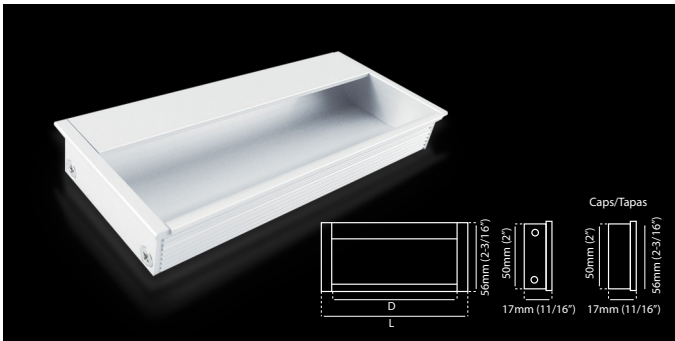

Material: Aluminum-Includes cut-out screws Material: Aluminio-Incluye tornillos recortables

CODE / CÓDIGO	FINISH / ACABADO	D	L	⊠
EM134-096-UCRANIA	● Aluminum/Aluminio	120mm (4-3/4")	124mm (4-7/8")	20/80
EM134-128-UCRANIA	● Aluminum/Aluminio	150mm (5-7/8")	156mm (6-1/8")	20/80
EM134-160-UCRANIA	● Aluminum/Aluminio	199mm (7-13/16")	206mm (8/18")	20/80
EM134-224-UCRANIA	● Aluminum/Aluminio	300mm (8-1/4")	306mm (12-1/16")	20/80
EM134-3000-UCRANIA	● Aluminum/Aluminio	PROFILE / PERFIL	3000mm (118")	1/10
EM134-CAPS	● Aluminum/Aluminio	CAPS / TAPAS		1/200

KKD2114 PERFIL

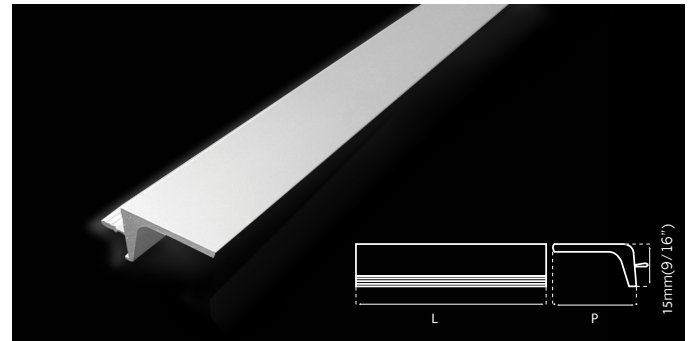

Material: Aluminum-Includes cut-out screws Material: Aluminio-Incluye tornillos recortables

CODE / CÓDIGO	FINISH / ACABADO	L	P	⊠
KKD2114BL	○ White/Blanco	3000mm (118")	42mm (1-5/8")	8
KKD2114CB	● Bright Aluminum/Aluminio Brillo	3000mm (118")	42mm (1-5/8")	8
KKD2114CM	● Matte Aluminum/Aluminio Mate	3000mm (118")	42mm (1-5/8")	8

POLONIA

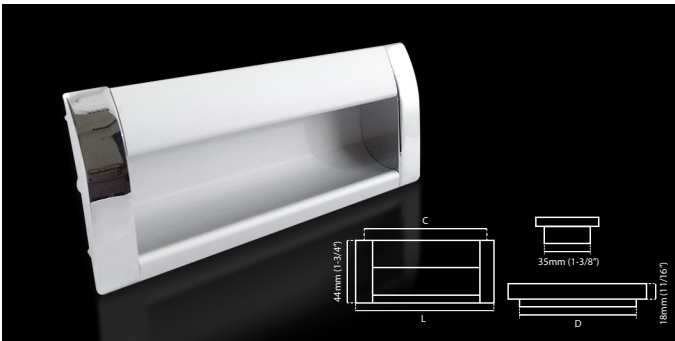

Material: Aluminum-Includes cut-out screws Material: Aluminio-Incluye tornillos recortables

CODE / CÓDIGO	FINISH / ACABADO	C	L	D	⊠
EM034-064-POLONIA	● Aluminum/Aluminio	64mm (2-1/2")	78mm (3-1/16")	69mm (2-11/16")	30/180
EM034-096-POLONIA	● Aluminum/Aluminio	96mm (3-3/4")	110mm (4-5/16")	101mm (4")	25/150
EM034-128-POLONIA	● Aluminum/Aluminio	128mm (5-1/16")	142mm (5-9/16")	133mm (5-1/4")	25/100
EM034-160-POLONIA	● Aluminum/Aluminio	160mm (6-5/16")	175mm (6-7/8")	166mm (6-9/16")	20/80
EM034-3000-POLONIA	● Aluminum/Aluminio	PROFILE / PERFIL	3000mm (118")		

KKD2010

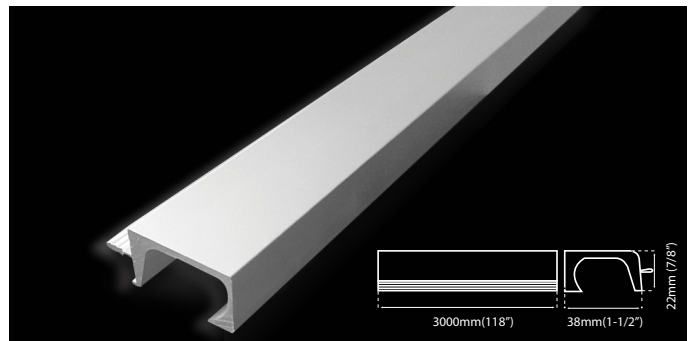

Material: Aluminum-Includes cut-out screws Material: Aluminio-Incluye tornillos recortables

CODE / CÓDIGO	FINISH / ACABADO	⊠
KKD2010BL	○ White/Blanco	8
KKD2010CB	● Bright Aluminum/Aluminio Brillo	8
KKD2010CM	● Matte Aluminum/Aluminio Mate	8

All measurements are approximate / Las medidas son aproximadas

NORUEGA

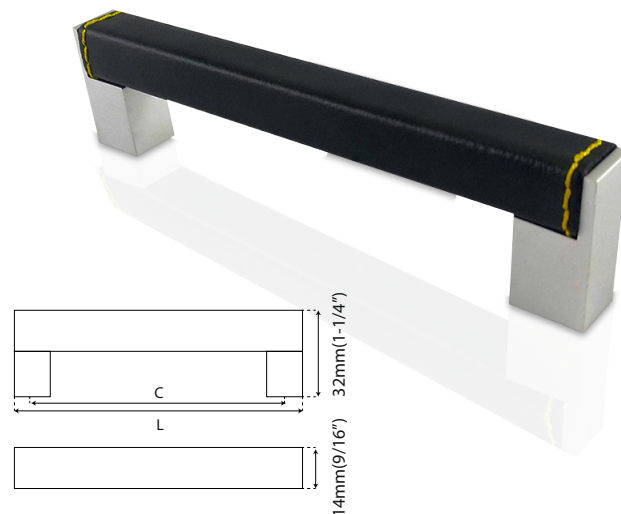

Material: Aluminum / Aluminio

CODE / CÓDIGO	FINISH / ACABADO	C	L	
EM155-096-NORUEGA	● Black Leather / Piel Negra	96mm (3-13/16")	116mm (4-9/16")	30/180
EM155-128-NORUEGA	● Black Leather / Piel Negra	128mm (5-1/16")	148mm (1-7/8")	25/150
EM155-320-NORUEGA	● Black Leather / Piel Negra	320mm (12-5/8")	340mm (13-3/8")	20/80

SUECIA

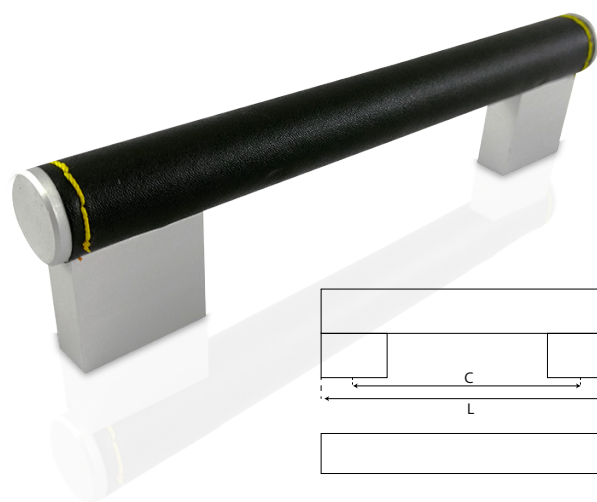

Material: Aluminum / Aluminio

CODE / CÓDIGO	FINISH / ACABADO	C	L	
EM156-096-SUECIA	● Black Leather / Piel Negra	96mm (3-13/16")	116mm (4-9/16")	30/180
EM156-128-SUECIA	● Black Leather / Piel Negra	128mm (5-1/16")	149mm (5-7/8")	25/150
EM156-320-SUECIA	● Black Leather / Piel Negra	320mm (12-5/8")	342mm (13-7/16")	20/80



All measurements are approximate / Las medidas son aproximadas



PANAMÁ

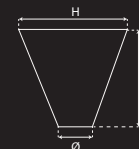

Material: Aluminum / Aluminio

CODE / CÓDIGO	FINISH / ACABADO	H	P	Ø	
EM186-25-PANAMA	● Aluminum/Aluminio	24mm (15/16")	22mm (7/8")	12mm (1/2")	100/600

JAMAICA

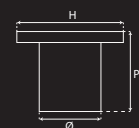

Material: Aluminum / Aluminio

CODE / CÓDIGO	FINISH / ACABADO	H	P	Ø	
EM189-25-JAMAICA	● Aluminum/Aluminio	24mm (15/16")	25mm (1")	18mm (11/16")	100/600

HAITÍ

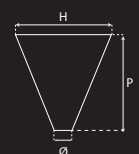

Material: Aluminum / Aluminio

CODE / CÓDIGO	FINISH / ACABADO	H	P	Ø	
EM187-22-HAITI	● Aluminum/Aluminio	22mm (7/8")	22mm (7/8")	10mm (3/8")	100/600

PUERTO RICO

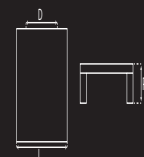
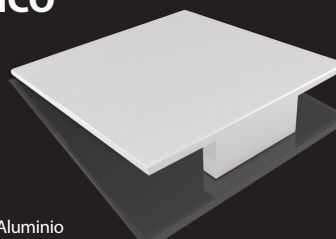

Material: Aluminum / Aluminio

CODE / CÓDIGO	FINISH / ACABADO	L	P	D	
EM145-32-PUERTORICO	● Aluminum/Aluminio	103mm (4-1/16")	20mm (13/16")	32mm (1-1/4")	15/60

PORTUGAL

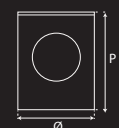

Material: Aluminum / Aluminio

CODE / CÓDIGO	FINISH / ACABADO	P	Ø	
EM094-016-PORTUGAL-B	● Aluminum/Aluminio	25mm (1")	16mm (5/8")	30/180
EM094-016-PORTUGAL-BMB	○ Black/Negro	25mm (1")	16mm (5/8")	30/180
EM094-018-PORTUGAL-B	● Aluminum/Aluminio	25mm (1")	18mm (11-16")	30/180
EM094-020-PORTUGAL-B	● Aluminum/Aluminio	25mm (1")	20mm (13/16")	30/180